

DTLF / VTLF 2.200
DTLF / VTLF 2.250
DTLF / VTLF 2.360
DVTLF 2.250

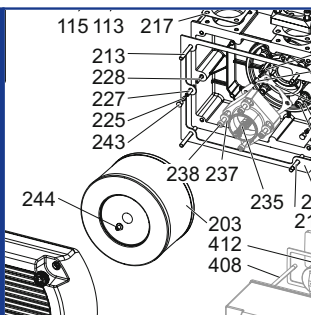

SERVICE

BECKER
D-42279 Wuppertal
www.becker-international.com

year

No. **A**

type **VTLF 2.250-XX**

frequency Hz

speed min⁻¹

power required kW

inlet capacity m³/h

pressure mbar

vacuum mbar

Made in Germany

Index Variante

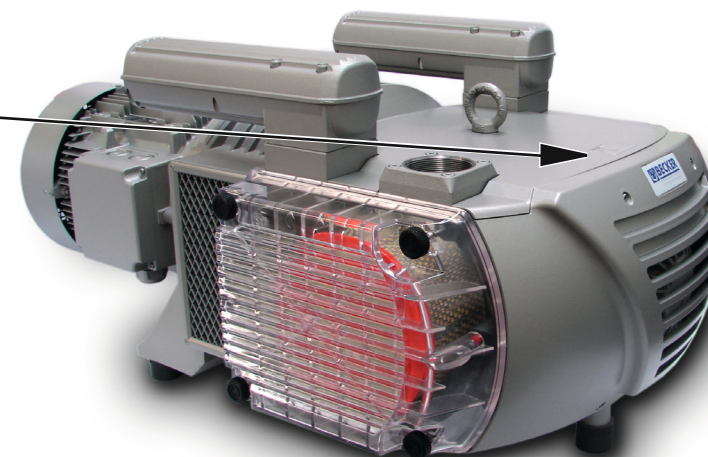

Ersatzteilliste
Spare parts list
Liste de pièces de rechange
Listino pezzi di ricambio
Lista de peças sobresselentes
Reserveonderdelenlijst
Atsarginių dalių sąrašas
Varuosad nimekirja
Rezerves daļu saraksts

Reservedelsliste
Reservdelslista
Varaosuettelo
Reservedelsliste
Wykaz części zamiennych
Tartalékalkatrész lista
Seznam náhradních dílů
Seznam nadomestnih delov
Zoznam náhradných dielov
Rezervni dijelovi popis

Lista pieselor de schimb
Páirteanna spártha liosta
Κατάλογος ανταλλακτικών
Yedek parça listesi
Списък на резервните части
Перечень запасных частей
スベアパーツリスト
예비 부품 목록
备用零件目录

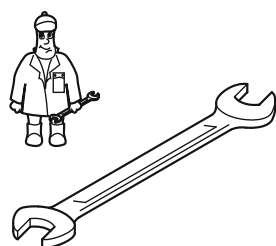

Wartung
Maintenance
Entretien
Manutenzione
Mantenimiento

Pos.	Menge ²⁾ Quantity Quantité Quantità Cantidad	Bestell-Nr. Ident No. No. Identification No. Identificazione No. de pedido	Bezeichnung Description Designation Designazione Descripción
□	1	549000 52200	Dichtungssatz, Complete set of seals, Jeu de joints, Kit di guarnizioni, Junta completa
108	SATZ/KIT	901367 01005	Schieber, Rotor Vane, Palette, Empujador
108	SATZ/KIT ³⁾	901325 00005	Sonderausführung, Special version, Version spéciale, Versione speciale, Versión especial
203	1	909512 00000	Filterpatrone, Filter cartridge, Cartouche Filtrante, Cartuccia filtro, Cartucho de filtro
203	1 ⁴⁾	909596 00000	Polyesterausführung, Polyester version, Version Polyester, Versione in poliester, versión poliéster
412	2 ⁵⁾	909510 00000	Filterpatrone, Filter cartridge, Cartouche Filtrante, Cartuccia filtro, Cartucho de filtro
520	1 ⁶⁾	909541 00000	Staubabscheider, Séparateur de poussière, Separatore di polveri, Separador de polvo

²⁾ erforderliche Bestellmenge / necessary order quantity / quantité nécessaire / quantità di ordinazione necessari / cantidad necesario
³⁾ nur für DTLF/VTLF 2.360 / only for DTLF/VTLF 2.360 / seulement pour DTLF/VTLF 2.360 / solo per DTLF/VTLF 2.360 / sólo para DTLF/VTLF 2.360
⁴⁾ nur für VTLF 2.2X0/6 / only for VTLF 2.2X0/6 / seulement pour VTLF 2.2X0/6 / solo per VTLF 2.2X0/6 / sólo para VTLF 2.2X0/6
⁵⁾ nur für VTLF 2.250/X SK / only for VTLF 2.250/X SK / seulement pour VTLF 2.250/X SK / solo per VTLF 2.250/X SK / sólo para VTLF 2.250/X SK
⁶⁾ nur für Pumpen mit integriertem Staubabscheider / only for pumps with integrated dust separator / seulement pour les pompes avec séparateur de poussière / solo per le pompe con separatore polvere / sólo para bombas con separador de polvo



() TLF 2.200 Standard
 () TLF 2.250
 () TLF 2.360

Standard



Variante



①
DTLF 2.250 K
DVTLF 2.250 K
 - mit Kühler
 - with cooler
 - avec refroidisseur
 - con raffreddamento
 - con refrigerador

②
VTLF 2.250 SK
 - mit Spülkühler
 - with special cooler
 - avec refroidisseur spécial
 - con radiatore speciale
 - con refrigerador especial

③
DVTLF KSK

④
VTLF 2.200/6
VTLF 2.250/6
 - Korrosionsschutz
 - corrosion protection
 - protection contre la corrosion
 - protezione anti-corrosione
 - protección contra la corrosión

⑤+⑥
VTLF 2.250/0-400
DTLF 2.250/0-400
 - mit Frequenzumrichter
 - with frequency convertor
 - avec convertisseur de fréquence
 - con convertitore di frequenza
 - con convertidor de frecuencia

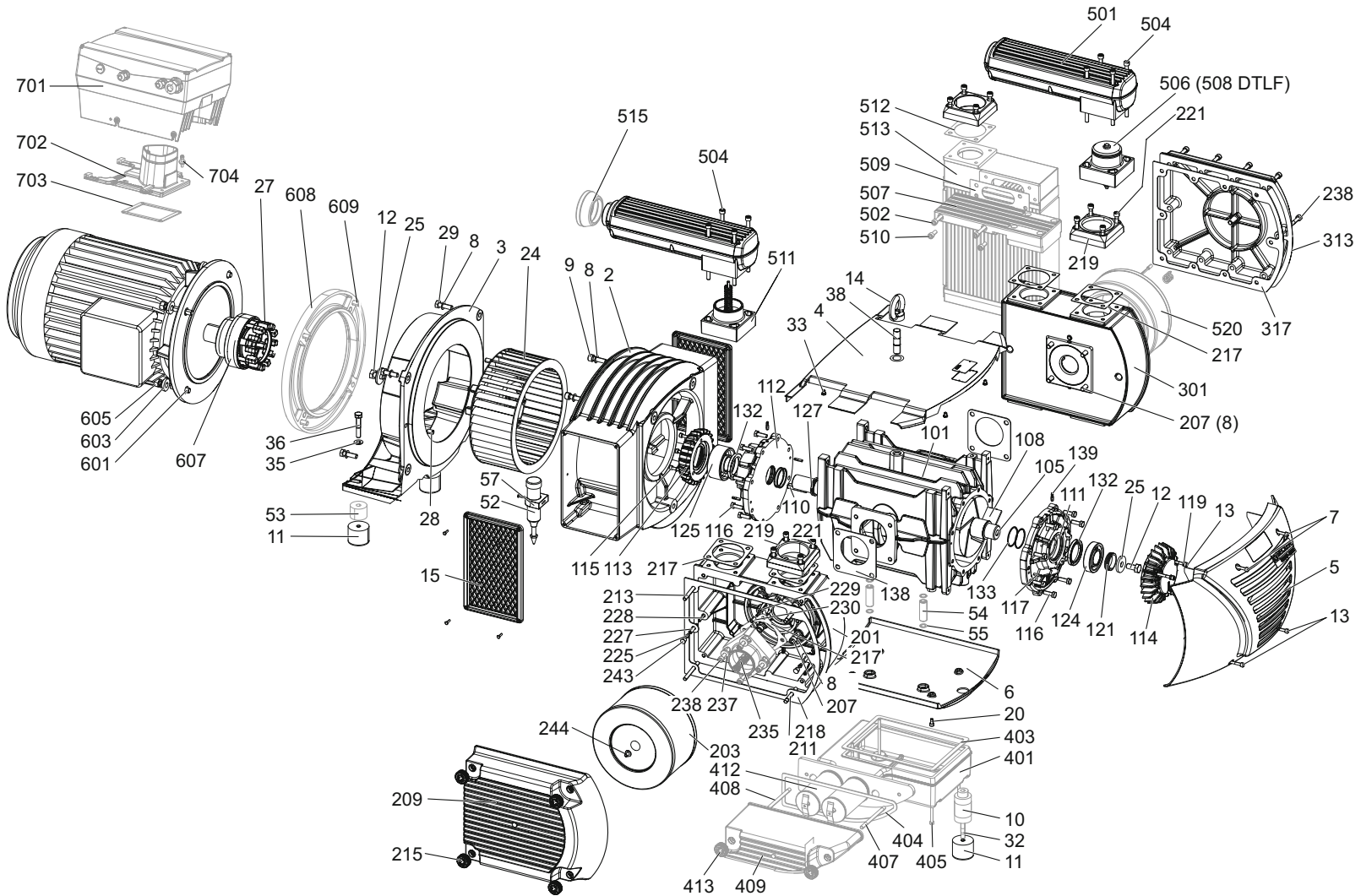

SERVICE ? i

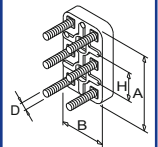
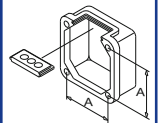
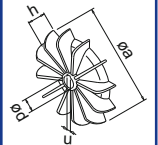
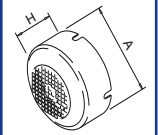
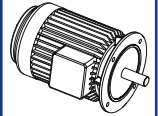



A INDEX	Pos.	Bestell Nr.	Beschreibung	
()TLF 2.200-2.360	□	549000 52200	DICHTUNGSSATZ ¹⁾	
	2	053200 52200	LATERNE	
	3	014905 52200	MOTORFLANSCH, B5/350 (DTLF+DVTLF)	
	3	014906 52200	MOTORFLANSCH, B5/300 (VTLF)	
	4	918302 52200	HAUBE (VTLF)	
	4	918303 52200	HAUBE (DTLF)	
	4	918304 52200	HAUBE (DVTLF)	
	5	920800 52200	LÜFTLEITHAUBE	
	6	918300 52200	HAUBE	
	7	945324 00000	INNENSECHSKANTSCHRAUBE, DIN912 M6X55	
	8	951710 00000	FEDERSCHEIBE	
	9	945351 00000	INNENSECHSKANTSCHRAUBE, DIN912 M10X35	
	10	011400 52200	DISTANZSTÜCK	
	11	741303 00000	GUMMI-PUFFER	
	12	945270 00000	WELLENENDSCHRAUBE	
	13	945363 00000	INNENSECHSKANTSCHRAUBE, DIN912 M6X40	
	14	951605 00000	RINGMUTTER, M16	
	15	960700 52200	LÜFTERHAUBE	
	20	901809 00000	INNENSECHSKANTSCHRAUBE, DIN912 M6X16	
	24	544503 22200	KUPPLUNGSHÄLFTE MIT VENTILATOR	
	25	949409 00000	UNTERLEGSCHLEIBE	
	27	902200 20000	KUPPLUNGS-RING	
	28	064900 30200	ZENTRIERBUCHSE	
	29	945238 00000	SECHSKANTSCHRAUBE, DIN933 M10X35	
	32	946930 00000	STIFTSCHRAUBE, DIN939 M10X60	
	33	951925 00000	GUMMIFORMTEIL	
	35	949453 00000	UNTERLEGSCHLEIBE	
	36	945236 00000	SECHSKANTSCHRAUBE, DIN933 M10X25	
	38	946962 00000	STIFTSCHRAUBE, DIN939 M16X40	
	52	743303 00000	SPEZIALFETT (FETTPRESSE, 50g)	
	57	967059 00000	HALTER	
	101	000100 52200	GEHÄUSE	
	105	020000 22200	KOLBEN	
	105	020000 51100	KOLBEN (DTLF+VTLF 2.360)	
	108	901367 01005	KOHLESCHIEBER - SATZ ²⁾	
	108	901325 00005	KOHLESCHIEBER (DTLF+VTLF 2.360) - SATZ ²⁾	
	110	947812 00000	PASSFEDER, DIN6885 B10X8X50	
	111	000700 52200	SEITENDECKEL	
	112	000800 52200	SEITENDECKEL	
	113	001101 52200	LAGERDECKEL	
	114	001000 52200	LAGERDECKEL	
	115	945321 00000	INNENSECHSKANTSCHRAUBE, DIN912 M6X25	
	116	945230 00000	SECHSKANTSCHRAUBE, DIN933 M8X25	
	117	948742 00000	PASSKERBSTIFT, DIN1472 5X20	
	119	951703 00000	FEDERSCHEIBE, DIN137 A6	
	121	068900 91000	FETT-TRANSPORTRING	
	124	906649 00000	WÄLZLAGER	
	125	906617 20000	WÄLZLAGER	
	127	511400 22200	DISTANZSCHEIBENSATZ	
	132	906577 00000	WELLENDICHRING, DF45X62X7	
	133	911310 00000	DICHTUNGSSCHLAUCH, 45X2	
	138	003100 52200	DICHTUNG	
	139	008102 52200	SCHLAUCHTUELLE	
	201	040100 52200	FILTERGEHÄUSE (VTLF+DVTLF)	
	201	040102 52200	FILTERGEHÄUSE (DTLF)	
	203	909512 00000	PATRONE (1x) ²⁾	
	207	945350 00000	INNENSECHSKANTSCHRAUBE, DIN912 M10X30	
	209	040200 52200	FILTERDECKEL	
	211	946919 00000	STIFTSCHRAUBE, DIN939 M8X50	
	213	946976 00000	STIFTSCHRAUBE, DIN939 M8X65	

A INDEX	Pos.	Bestell Nr.	Beschreibung	
	215	921501 50000	HANDGRIF	
	217	007900 22200	DICHTUNG	
	218	008900 52200	DICHTUNG	
	219	007801 52200	GEWINDEFANSCH	
	221	945333 00000	INNENSECHSKANTSCHRAUBE, DIN912 M8X35	
	225	949001 00000	SCHMIERNIPPEL, DIN3405	
	227	008103 52200	SCHLAUCHTÜLLE	
	228	742601 52200	SCHMIERSCHLAUCH	
	229	952006 00000	SPANNHÜLSE	
	230	042600 10100	SCHLAUCH	
	235	535003 99619	RÜCKSCHLAGVENTIL - OPTIONAL	
	237	949450 00000	UNTERLEGSCHLEIBE	
	238	945336 00000	INNENSECHSKANTSCHRAUBE, DIN912 M8X50	
	243	912888 00000	STOPFEN	
	244	912801 00000	GUMMIFORMTEIL	
	301	040101 52200	FILTERGEHÄUSE (VTLF)	
	301	040103 52200	FILTERGEHÄUSE (DTLF+DVTLF)	
	313	040201 52200	FILTERDECKEL	
	317	000300 52200	DICHTUNG	
	501	539801 52200	SCHALLDÄMPFER	
	504	945381 00000	INNENSECHSKANTSCHRAUBE, DIN912 M8X100	
	504	945346 00000	INNENSECHSKANTSCHRAUBE, DIN912 M8X140	
	506	534000 99619	ABBLASEVENTIL (VTLF)	
	508	534002 99619	DRUCKSICHERHEITSVENTIL	
	511	535001 99619	VAKUUMSICHERHEITSVENTIL	
	515	734900 99522	KAPPE - OPTIONAL	
	520	909541 00000	STAUBABSCHIEDER - OPTIONAL	
	601	946945 00000	STIFTSCHRAUBE, DIN939 M12X35	
	603	949455 00000	U-SCHLEIBE, DIN7349	
	605	947107 00000	SECHSKANTMUTTER, DIN934 M12	
	607	902100 22200	MOTORKUPPLUNG, Ø 38mm (B5/300)	
	607	902101 22200	MOTORKUPPLUNG, Ø 42mm (5.5...11kW)	
	607	902102 22200	MOTORKUPPLUNG, Ø 48mm (15kW)	
	608	003600 52200	ZWISCHENFLANSCH (B5/300)	
	609	945349 00000	INNENSECHSKANTSCHRAUBE, DIN912 M10X25	

¹⁾ **Dichtungssatz** - 54900052200 - Pos.: 133, 138, 217, 218, 317

²⁾ erforderliche Bestellmenge / Wartung

A INDEX	Pos.	Ident No.	Description	
()TLF 2.200-2.360	□	549000 52200	SET OF SEALS ¹⁾	
	2	053200 52200	CONNECTION FLANGE	
	3	014905 52200	MOTORFLANGE, B5/350 (DTLF+DVTLF)	
	3	014906 52200	MOTORFLANGE, B5/300 (VTLF)	
	4	918302 52200	COVERING HOOD (VTLF)	
	4	918303 52200	COVERING HOOD (DTLF)	
	4	918304 52200	COVERING HOOD (DVTLF)	
	5	920800 52200	AIR GUIDE COVER RING	
	6	918300 52200	COVERING HOOD	
	7	945324 00000	SOCKET HEAD SCREW	
	8	951710 00000	SPRING DISC	
	9	945351 00000	SOCKET HEAD SCREW	
	10	011400 52200	DISTANCE-DISC	
	11	741303 00000	RUBBER BUFFER	
	12	945270 00000	SHAFT END BOLD	
	13	945363 00000	SOCKET HEAD SCREW	
	14	951605 00000	RING UNIT	
	15	960700 52200	VENTILATOR HOOD	
	20	901809 00000	SOCKET HEAD SCREW	
	24	544503 22200	COUPLING WITH FAN	
	25	949409 00000	WASHER	
27	902200 20000	COUPLING RING		
28	064900 30200	CENTRING BUSH		
29	945238 00000	HEX-HEAD SCREW		
32	946930 00000	STUD		
33	951925 00000	RUBBER ELEMENT		
35	949453 00000	WASHER		
36	945236 00000	HEX-HEAD SCREW		
38	946962 00000	STUD		
52	743303 00000	SPECIAL GREASE (GREASE PRESS, 50g)		
57	967059 00000	HOLDER		
101	000100 52200	PUMP BODY		
105	020000 22200	ROTOR		
105	020000 51100	ROTOR (DTLF+VTLF 2.360)		
108	901367 01005	ROTOR VANES - KIT ²⁾		
108	901325 00005	ROTOR VANES (DTLF+VTLF 2.360) - KIT ²⁾		
110	947812 00000	KEY		
111	000700 52200	LID RIGHT		
112	000800 52200	LID LEFT		
113	001101 52200	BEARING COVER		
114	001000 52200	BEARING COVER		
115	945321 00000	SOCKET HEAD SCREW		
116	945230 00000	HEX-HEAD SCREW		
117	948742 00000	STRAIGHT PIN		
119	951703 00000	SPRING DISC		
121	068900 91000	GREASE DISTRIBUTION WASHER		
124	906649 00000	BALL BEARING		
125	906617 20000	BALL BEARING		
127	511400 22200	SPACER SET		
132	906577 00000	SHAFT-SEALING RING		
133	911310 00000	SEAL		
138	003100 52200	GASKET		
139	008102 52200	CONDUIT-GREASE		
201	040100 52200	FILTER HOUSING (VTLF+DVTLF)		
201	040102 52200	FILTER HOUSING (DTLF)		
203	909512 00000	FILTER CARTRIDGE (1x) ²⁾		
207	945350 00000	SOCKET HEAD SCREW		
209	040200 52200	FILTER COVER		
211	946919 00000	STUD		
213	946976 00000	STUD		

A INDEX	Pos.	Ident No.	Description	
	215	921501 50000	HANDLE	
	217	007900 22200	GASKET	
	218	008900 52200	GASKET	
	219	007801 52200	CONNECTING FLANGE	
	221	945333 00000	SOCKET HEAD SCREW	
	225	949001 00000	GREASE NIPPLE	
	227	008103 52200	HOSE CONNECTOR	
	228	742601 52200	LUBRICATION LINE	
	229	952006 00000	FIXING SLEEVE	
	230	042600 10100	FLEXIBLE HOSE	
	235	535003 99619	NON RETURN VALVE - OPTIONAL	
	237	949450 00000	WASHER	
	238	945336 00000	SOCKET HEAD SCREW	
	243	912888 00000	PLUG	
	244	912801 00000	RUBBER ELEMENT	
	301	040101 52200	FILTER HOUSING (VTLF)	
	301	040103 52200	FILTER HOUSING (DTLF+DVTLF)	
	313	040201 52200	FILTER COVER	
	317	000300 52200	GASKET	
	501	539801 52200	SILENCER	
	504	945381 00000	SOCKET HEAD SCREW, DIN912 M8X100	
	504	945346 00000	SOCKET HEAD SCREW, DIN912 M8X140	
	506	534000 99619	BLOW-OFF VALVE	
	508	534002 99619	PRESSURE RELIEF VALVE	
	511	535001 99619	VACUUM RELIEF VALVE	
	515	734900 99522	CAP - OPTIONAL	
	520	909541 00000	DUST SEPARATOT - OPTIONAL	
	601	946945 00000	STUD	
	603	949455 00000	WASHER	
	605	947107 00000	HEX. NUT	
	607	902100 22200	COUPLING MOTOR SIDE, Ø 38mm (B5/300)	
	607	902101 22200	COUPLING MOTOR SIDE, Ø 42mm (5.5...11kW)	
	607	902102 22200	COUPLING MOTOR SIDE, Ø 48mm (15kW)	
	608	003600 52200	INTERMEDIATE FLANGE (B5/300)	
	609	945349 00000	SOCKET HEAD SCREW	

¹⁾ Set of seals - 54900052200 - Pos.: 133, 138, 217, 218, 317

²⁾ necessary order quantity / maintenance

A INDICE	Pos.	No. Identification	Designation
() TLF 2.200-2.360	□	549000 52200	JEU DE JOINTS ¹⁾
	2	053200 52200	BRIDE DE RACCORDEMENT
	3	014905 52200	BRIDE POUR MOTEUR, B5/350 (DTLF+DVTLF)
	3	014906 52200	BRIDE POUR MOTEUR, B5/300 (VTLF)
	4	918302 52200	CARTER (VTLF)
	4	918303 52200	CARTER (DTLF)
	4	918304 52200	CARTER (DVTLF)
	5	920800 52200	CAPOT DE CANALISATION DE L'AIR
	6	918300 52200	CARTER
	7	945324 00000	VIS HEXAGONALE INTERNE
	8	951710 00000	DISQUE DE RESSORT
	9	945351 00000	VIS HEXAGONALE INTERNE
	10	011400 52200	DISQUE DE DISTANCE
	11	741303 00000	AMORTISSEUR EN CAOUTCHOUC
	12	945270 00000	VIS BOUT D'ARBRE
	13	945363 00000	VIS HEXAGONALE INTERNE
	14	951605 00000	ÉCROU À ANNEAU
	15	960700 52200	CARTER DE VENTILATEUR
	20	901809 00000	VIS HEXAGONALE INTERNE
	24	544503 22200	ACCOUPLLEMENT AVEC VENTILATEUR
	25	949409 00000	RONDELLE
	27	902200 20000	DISQUE D'ACCOUPLLEMENT
	28	064900 30200	BAGUE DE CENTRAGE
	29	945238 00000	VIS HEXAGONALE
	32	946930 00000	PRISONNIER
	33	951925 00000	ELEMENT EN CAOUTCHOUC
	35	949453 00000	RONDELLE
	36	945236 00000	VIS HEXAGONALE
	38	946962 00000	TOURILLON
	52	743303 00000	GRAISSE SPÉCIFIQUE (POMPE À GRAISSE, 50g)
	57	967059 00000	SUPPORT
	101	000100 52200	CORP DE POMPE
	105	020000 22200	PISTON
	105	020000 51100	PISTON (DTLF+VTLF 2.360)
	108	901367 01005	PALETTE DE CHARBON - KIT ²⁾
	108	901325 00005	PALETTE DE CHARBON (DTLF+VTLF 2.360) - KIT ²⁾
	110	947812 00000	CLAVETTE
	111	000700 52200	COUVERCLE A DROITE
	112	000800 52200	COUVERCLE A GAUCHE
	113	001101 52200	COUVERCLE DE ROULEMENTE
	114	001000 52200	COUVERCLE DE ROULEMENTE
	115	945321 00000	VIS HEXAGONALE INTERNE
	116	945230 00000	VIS HEXAGONALE
	117	948742 00000	GOUPILLE CYLINDRIQUE
	119	951703 00000	DISQUE DE RESSORT
	121	068900 91000	BAGUE DE TRANSPORT DE GRAISSE
	124	906649 00000	ROULEMENT A BILLES
	125	906617 20000	ROULEMENT A BILLES
	127	511400 22200	JEU DE DISQUES DE TOLERANCE
	132	906577 00000	BAGUE D'ETANCHEITE
	133	911310 00000	JOINT
	138	003100 52200	JOINT
	139	008102 52200	TUYEAU DE GRAISSAGE
	201	040100 52200	BOITE POUR FILTRE (VTLF+DVTLF)
	201	040102 52200	BOITE POUR FILTRE (DTLF)
	203	909512 00000	CARTOUCHE FILTRANTE (1x) ²⁾
	207	945350 00000	VIS HEXAGONALE INTERNE
	209	040200 52200	COUVERCLE DU FILTRE
	211	946919 00000	PRISONNIER
	213	946976 00000	PRISONNIER

A INDICE	Pos.	No. Identification	Designation
	215	921501 50000	POIGNEE
	217	007900 22200	JOINT
	218	008900 52200	JOINT
	219	007801 52200	BOURRELET DE RACCORDEMENT
	221	945333 00000	VIS HEXAGONALE INTERNE
	225	949001 00000	GRAISSEUR
	227	008103 52200	RACCORD À QUEUE CRANTÉE
	228	742601 52200	CONDUITE DE GRAISSAGE
	229	952006 00000	MANCHON DE FIXATION
	230	042600 10100	TUYAUTERIE FLEXIBLE
	235	535003 99619	SOUPAPE DE RETENUE - EN OPTION
	237	949450 00000	RONDELLE
	238	945336 00000	VIS HEXAGONALE INTERNE
	243	912888 00000	BOUCHON
	244	912801 00000	ELEMENT EN CAOUTCHOUC
	301	040101 52200	BOITE POUR FILTRE (VTLF)
	301	040103 52200	BOITE POUR FILTRE (DTLF+DVTLF)
	313	040201 52200	COUVERCLE DU FILTRE
	317	000300 52200	JOINT
	501	539801 52200	SILENCIEUX
	504	945381 00000	VIS HEXAGONALE INTERNE, DIN912 M8X100
	504	945346 00000	VIS HEXAGONALE INTERNE, DIN912 M8X140
	506	534000 99619	SOUPAPE D'ÉCHAPPEMENT
	508	534002 99619	SOUPAPE DE SÉCURITÉ - PRESSION
	511	535001 99619	SOUPAPE DE SÉCURITÉ - VIDE
	515	734900 99522	CAPUCHON - EN OPTION
	520	909541 00000	SÉPARATEUR DE LA POUSSIÈRE - EN OPTION
	601	946945 00000	PRISONNIER
	603	949455 00000	RONDELLE
	605	947107 00000	ECROU A 6 PANS
	607	902100 22200	ACCOUPLLEMENT MOTEUR, Ø 38mm (B5/300)
	607	902101 22200	ACCOUPLLEMENT MOTEUR, Ø 42mm (5.5...11kW)
	607	902102 22200	ACCOUPLLEMENT MOTEUR, Ø 48mm (15kW)
	608	003600 52200	BRIDE INTERMÉDIAIRE (B5/300)
	609	945349 00000	VIS HEXAGONALE INTERNE

¹⁾ Jeu de joints - 54900052200 - Pos.: 133, 138, 217, 218, 317

²⁾ quantité nécessaire / entretien

A INDICE	Pos.	No. Identificazione	Designazione
() TLF 2.200-2.360	□	549000 52200	SERIE DI GUARNIZIONE ¹⁾
	2	053200 52200	FLANGIA DI RACCORDE
	3	014905 52200	FLANGIA PER MOTORE, B5/350 (DTLF+DVTLF)
	3	014906 52200	FLANGIA PER MOTORE, B5/300 (VTLF)
	4	918302 52200	CARTER (VTLF)
	4	918303 52200	CARTER (DTLF)
	4	918304 52200	CARTER (DVTLF)
	5	920800 52200	CONDOTTA ARIA
	6	918300 52200	CARTER
	7	945324 00000	VITE ESAGONALE INTERNA
	8	951710 00000	DISCO A MOLLA
	9	945351 00000	VITE ESAGONALE INTERNA
	10	011400 52200	DISCO DISTANZA
	11	741303 00000	AMMORTIZZATORE IN GOMMA
	12	945270 00000	VITE DI CHIUSURA ALBERO
	13	945363 00000	VITE ESAGONALE INTERNA
	14	951605 00000	DADO AD OCCHIELLO
	15	960700 52200	CARTER DEL VENTILATORE
	20	901809 00000	VITE ESAGONALE INTERNA
	24	544503 22200	GIUNTO CON VENTILATORE
	25	949409 00000	RONDELLA
27	902200 20000	DISCO GUINTO	
28	064900 30200	BOCCOLA DI CENTRAGGIO	
29	945238 00000	VITE ESAGONALE	
32	946930 00000	L'ASTA A VITE	
33	951925 00000	ELEMENTO IN GOMMA	
35	949453 00000	RONDELLA	
36	945236 00000	VITE ESAGONALE	
38	946962 00000	VITE PRIGIONIERA	
52	743303 00000	GRASSO SPECIALE (INGRASSATORE A PISTOLA, 50g)	
57	967059 00000	SUPPORTO	
101	000100 52200	CARCASSA	
105	020000 22200	ROTORE	
105	020000 51100	ROTORE (DTLF+VTLF 2.360)	
108	901367 01005	PALETTE - KIT ²⁾	
108	901325 00005	PALETTE (DTLF+VTLF 2.360) - KIT ²⁾	
110	947812 00000	CHIAVETTA	
111	000700 52200	COPERCHIO DESTRA	
112	000800 52200	COPERCHIO SINISTRA	
113	001101 52200	COPERCHIO CUSCINETTO	
114	001000 52200	COPERCHIO CUSCINETTO	
115	945321 00000	VITE ESAGONALE INTERNA	
116	945230 00000	VITE ESAGONALE	
117	948742 00000	PERNO	
119	951703 00000	DISCO A MOLLA	
121	068900 91000	ANELLO INGRASSAGGIO	
124	906649 00000	CUSCINETTO A SFERA	
125	906617 20000	CUSCINETTO A SFERA	
127	511400 22200	SERIE DI DISCO A DISTANZA	
132	906577 00000	GUARNIZIONE PER L'ALBERO	
133	911310 00000	GUARNIZIONE	
138	003100 52200	GUARNIZIONE	
139	008102 52200	TUBETTO INGRASSATORE	
201	040100 52200	CARCASSA DEL FILTRO (VTLF+DVTLF)	
201	040102 52200	CARCASSA DEL FILTRO (DTLF)	
203	909512 00000	CARTUCCIA FILTRO (1x) ²⁾	
207	945350 00000	VITE ESAGONALE INTERNA	
209	040200 52200	COPERCHIO FILTRO	
211	946919 00000	L'ASTA A VITE	
213	946976 00000	L'ASTA A VITE	

A INDICE	Pos.	No. Identificazione	Designazione
	215	921501 50000	MANETTA
	217	007900 22200	GUARNIZIONE
	218	008900 52200	GUARNIZIONE
	219	007801 52200	FLANGIA DI RACCORDO
	221	945333 00000	VITE ESAGONALE INTERNA
	225	949001 00000	RACCORDO DI LUBRIFICAZIONE
	227	008103 52200	TUBO CONNETTORE
	228	742601 52200	TUBAZIONE DI LUBRIFICAZIONE
	229	952006 00000	MANICOTTO DI FISSAZIONE
	230	042600 10100	TUBAZIONE FLESSIBILE
	235	535003 99619	VALVOLA DI RITENUTA - OPTIONALE
	237	949450 00000	RONDELLA
	238	945336 00000	VITE ESAGONALE INTERNA
	243	912888 00000	TAPPO
	244	912801 00000	ELEMENTO IN GOMMA
	301	040101 52200	CARCASSA DEL FILTRO (VTLF)
	301	040103 52200	CARCASSA DEL FILTRO (DTLF+DVTLF)
	313	040201 52200	COPERCHIO FILTRO
	317	000300 52200	GUARNIZIONE
	501	539801 52200	SILENZIATORE
	504	945381 00000	VITE ESAGONALE INTERNA, DIN912 M8X100
	504	945346 00000	VITE ESAGONALE INTERNA, DIN912 M8X140
	506	534000 99619	VALVOLA DI SFIATO
	508	534002 99619	VALVOLA DI SICUREZZA - PRESSIONE
	511	535001 99619	VALVOLA DI SICUREZZA - VUOTO
	515	734900 99522	GUAINA - OPTIONALE
	520	909541 00000	SEPARATORE DELLE POLVERI - OPTIONALE
	601	946945 00000	L'ASTA A VITE
	603	949455 00000	RONDELLA
	605	947107 00000	DADO ESAGONALE
	607	902100 22200	GIUNTO MOTORE, Ø 38mm (B5/300)
	607	902101 22200	GIUNTO MOTORE, Ø 42mm (5.5...11kW)
	607	902102 22200	GIUNTO MOTORE, Ø 48mm (15kW)
	608	003600 52200	FLANGIA INTERMEDIA (B5/300)
	609	945349 00000	VITE ESAGONALE INTERNA

¹⁾ Serie di guarnizione - 54900052200 - Pos.: 133, 138, 217, 218, 317

²⁾ quantità di ordinazione necessari / manutenzione

A INDICE	Pos.	No. De pedido	Descripción	
() TLF 2.200-2.360	□	549000 52200	JUEGO DE JUNTAS ¹⁾	
	2	053200 52200	FAROL	
	3	014905 52200	BRIDA DE MOTOR, B5/350 (DTLF+DVTLF)	
	3	014906 52200	BRIDA DE MOTOR, B5/300 (VTLF)	
	4	918302 52200	CAPERUZA DE RECUBRIMIENTO (VTLF)	
	4	918303 52200	CAPERUZA DE RECUBRIMIENTO (DTLF)	
	4	918304 52200	CAPERUZA DE RECUBRIMIENTO (DVTLF)	
	5	920800 52200	ANILLO CONDUCTOR DE AIRE	
	6	918300 52200	CAPERUZA DE RECUBRIMIENTO	
	7	945324 00000	TORNILLO HEXAGONAL INTERIOR	
	8	951710 00000	ARANDELA ELÁSTICA	
	9	945351 00000	TORNILLO HEXAGONAL INTERIOR	
	10	011400 52200	PIEZA DISTANCIADORA	
	11	741303 00000	AMORTIGUADOR DE GOMA	
	12	945270 00000	TORNILLO TERMINAL DE ÁRBOL	
	13	945363 00000	TORNILLO HEXAGONAL INTERIOR	
	14	951605 00000	TUERCA M16	
	15	960700 52200	CAPERUZA DE VENTILADOR	
	20	901809 00000	TORNILLO HEXAGONAL INTERIOR	
	24	544503 22200	MITAD DE ACOPLAMIENTO CON VENTILADOR	
	25	949409 00000	ARANDELA	
	27	902200 20000	DISCO DE ACOPLAMIENTO	
	28	064900 30200	MANGUITO DE CENTRADO	
	29	945238 00000	TORNILLO DE CABEZA HEXAGONAL	
	32	946930 00000	ESPÁRRAGO	
	33	951925 00000	PIEZA DE ORMA DE GOMA	
	35	949453 00000	ARANDELA	
	36	945236 00000	TORNILLO DE CABEZA HEXAGONAL	
	38	946962 00000	ESPÁRRAGO	
	52	743303 00000	GRASA ESPECIAL (PISTOLA DE GRASA, 50g)	
	57	967059 00000	SOPORTE	
	101	000100 52200	CARCASA	
	105	020000 22200	ÉMBOLO	
	105	020000 51100	ÉMBOLO (DTLF+VTLF 2.360)	
	108	901367 01005	DESPLAZADOR DE CARBÓN - KIT ²⁾	
	108	901325 00005	DESPLAZADOR DE CARBÓN (DTLF+VTLF 2.360) - KIT ²⁾	
	110	947812 00000	LENGÜETA DE AJUSTE	
	111	000700 52200	TAPA LATERAL DERECHA	
	112	000800 52200	TAPA LATERAL IZQUIERDA	
	113	001101 52200	TAPA DE COJINETE	
	114	001000 52200	TAPA DE COJINETE	
	115	945321 00000	TORNILLO HEXAGONAL INTERIOR	
	116	945230 00000	TORNILLO DE CABEZA HEXAGONAL	
	117	948742 00000	PASADOR ENTALLADO DE AJUSTE	
	119	951703 00000	ARANDELA ELÁSTICA	
	121	068900 91000	ANILLO DE TRANSPORTE DE GRASA	
	124	906649 00000	COJINETE DE RODAMIENTO	
	125	906617 20000	COJINETE DE RODAMIENTO	
	127	511400 22200	JUEGO DE ARANDELAS DE AJUSTE	
	132	906577 00000	ANILLO DE JUNTA DE ÁRBOL	
	133	911310 00000	MANGUERA DE JUNTA	
	138	003100 52200	JUNTA	
	139	008102 52200	TUBITO DE GRASA	
	201	040100 52200	CARCASA DE FILTRO (VTLF+DVTLF)	
	201	040102 52200	CARCASA DE FILTRO (DTLF)	
	203	909512 00000	CARTUCHO DE FILTRO (1x) ²⁾	
	207	945350 00000	TORNILLO HEXAGONAL INTERIOR	
	209	040200 52200	TAPA DE FILTRO	
	211	946919 00000	ESPÁRRAGO	
	213	946976 00000	ESPÁRRAGO	

A INDICE	Pos.	No. De pedido	Descripción	
	215	921501 50000	EMPUÑADURA	
	217	007900 22200	JUNTA	
	218	008900 52200	JUNTA	
	219	007801 52200	BRIDA DE EMPALME	
	221	945333 00000	TORNILLO HEXAGONAL INTERIOR	
	225	949001 00000	BOQUILLA DE LUBRICACIÓN	
	227	008103 52200	EMPALME DE EXTREMIDAD	
	228	742601 52200	CONDUCTO DE ENGRASE	
	229	952006 00000	MANGUITO DE FIJACIÓN	
	230	042600 10100	MANGUERA	
	235	535003 99619	VÁLVULA DE RETENCIÓN - OPCIONAL	
	237	949450 00000	ARANDELA	
	238	945336 00000	TORNILLO HEXAGONAL INTERIOR	
	243	912888 00000	TAPÓN	
	244	912801 00000	PIEZA DE ORMA DE GOMA	
	301	040101 52200	CARCASA DE FILTRO (VTLF)	
	301	040103 52200	CARCASA DE FILTRO (DTLF+DVTLF)	
	313	040201 52200	TAPA DE FILTRO	
	317	000300 52200	JUNTA	
	501	539801 52200	SILENCIADOR	
	504	945381 00000	TORNILLO HEXAGONAL INTERIOR, DIN912 M8X100	
	504	945346 00000	TORNILLO HEXAGONAL INTERIOR, DIN912 M8X140	
	506	534000 99619	VÁLVULA DE ESCAPE	
	508	534002 99619	VÁLVULA DE SEGURIDAD - PRESIÓN	
	511	535001 99619	VÁLVULA DE SEGURIDAD - VACÍO	
	515	734900 99522	TAPA - OPCIONAL	
	520	909541 00000	SEPARADOR DE POLVO - OPCIONAL	
	601	946945 00000	ESPÁRRAGO	
	603	949455 00000	ARANDELA	
	605	947107 00000	TUERCA HEXAGONAL	
	607	902100 22200	ACOPLAMIENTO DE MOTOR, Ø 38mm (B5/300)	
	607	902101 22200	ACOPLAMIENTO DE MOTOR, Ø 42mm (5.5...11kW)	
	607	902102 22200	ACOPLAMIENTO DE MOTOR, Ø 48mm (15kW)	
	608	003600 52200	BRIDA INTERMEDIO (B5/300)	
	609	945349 00000	TORNILLO HEXAGONAL INTERIOR	

¹⁾ Junta completa - 54900052200 - Pos.: 133, 138, 217, 218, 317

²⁾ cantidad necesario / mantenimiento



()TLF 2.200 ()TLF 2.250 ()TLF 2.360	Variante 	Pos. ²⁾	Bestell Nr. / Ident No. / No. Identification / No. Identificazione / No. De pedido		Beschreibung / Description / Designation / Designazione / Descripcion
① DTLF 2.250 K DVTLF 2.250 K - mit Kühler - with cooler - avec refroidisseur - con raffreddamento - con refrigerador		502	945345 00000		INNENSECHSKANTSCHRAUBE / SOCKET HEAD SCREW / VIS HEXAGONALE INTERNE / VITE ESAGONALE INTERNA / TORNILLO HEXAGONAL INTERIOR
		507	060301 52200		ANSCHLUSSSTÜCK / MANIFOLD / BOÎTE DE DÉRIVATION / SCATOLA DI CONNESSIONE / CAJA DE CONEXIÓN
		509	008903 22200		DICHTUNG / GASKET / JOINT / GUARNIZIONE / JUNTA
		510	945330 04000		INNENSECHSKANTSCHRAUBE / SOCKET HEAD SCREW / VIS HEXAGONALE INTERNE / VITE ESAGONALE INTERNA / TORNILLO HEXAGONAL INTERIOR
		512	007900 22200		DICHTUNG / GASKET / JOINT / GUARNIZIONE / JUNTA
		513	560201 22200		KÜHLER / COOLER / REFRROIDISSEUR / RAFFREDDATORE / REFRIGERADOR
② VTFL 2.250 SK - mit Spülkühler - with special cooler - avec refroidisseur spécial - con radiatore speciale - con refrigerador especial		10	011401 52200	011400 52200	DISTANZSCHEIBE / DISTANCE-DISK / DISQUE AJUSTAGE / DISCO DISTANZA / ARANDELA DISTANCIADORA
		32	946969 00000	946930 00000	STIFTSCHRAUBE / STUD / PRISONNIER / L'ASTA A VITE / ESPÁRRAGO
		36	945129 00000	945236 00000	SECHSKANTSCHRAUBE / HEX-HEAD SCREW / VIS HEXAGONALE / VITE ESAGONALE / TORNILLO DE CABEZA HEXAGONAL
		53	011400 22200		DISTANZSCHEIBE / DISTANCE-DISK / DISQUE AJUSTAGE / DISCO DISTANZA / ARANDELA DISTANCIADORA
		54	011402 52200		DISTANZSCHEIBE / DISTANCE-DISK / DISQUE AJUSTAGE / DISCO DISTANZA / ARANDELA DISTANCIADORA
		55	913110 01000		DICHTUNG / GASKET / JOINT / GUARNIZIONE / JUNTA
		401	004600 52200		FILTERGEHÄUSE / FILTER HOUSING / BOITE POUR FILTRE / CONTENITORE FILTRO / CARCASA DE FILTRO
		403	008901 52200		DICHTUNG / GASKET / JOINT / GUARNIZIONE / JUNTA
		404	008902 52200		DICHTUNG / GASKET / JOINT / GUARNIZIONE / JUNTA
		405	945376 00000		INNENSECHSKANTSCHRAUBE / SOCKET HEAD SCREW / VIS HEXAGONALE INTERNE / VITE ESAGONALE INTERNA / TORNILLO HEXAGONAL INTERIOR
		407	946973 00000		STIFTSCHRAUBE / STUD / PRISONNIER / L'ASTA A VITE / ESPÁRRAGO
		408	946975 00000		STIFTSCHRAUBE / STUD / PRISONNIER / L'ASTA A VITE / ESPÁRRAGO
		409	040203 52200		DECKEL / COVER / COUVERCLE / COPERCHIO / TAPA
		412	909510 00000		FILTERPATRONE / FILTER CARTRIDGE / CARTOUCHE FILTRANTE / CARTUCCIA FILTRO / CARTUCHO DE FILTRO
		413	921501 50000		HANDGRIFF / HANDLE / POIGNEE / MANETTA / EMPUÑADURA

²⁾ variantenabhängige Bauteile / variant-dependent components / composants variante-dependantes / componenti variante-dispendenti / componentes variante-dependientes
³⁾ nur bei Verwendung der Motorvariante 42969601300000CT erforderlich / only necessary when using the engine variant 42969601300000CT / uniquement nécessaire lors de l'utilisation de la variante du moteur 42969601300000CT / necessario solo quando si utilizza la variante del motore 42969601300000CT / solo es necesario cuando se utiliza la variante del motor 42969601300000CT

()TLF 2.200 ()TLF 2.250 ()TLF 2.360	Variante 	Pos. ²⁾	Bestell Nr. / Ident No. / No. Identification / No. Identificazione / No. De pedido		Beschreibung / Description / Designation / Designazione / Descripcion
③ DVTLF 2.250 KSK - mit Kühler und Spülkühler - with special cooler - avec refroidisseur spécial - con radiatore speciale - con refrigerador especial		10	011401 52200	011400-52200	DISTANZSCHEIBE / DISTANCE-DISK / DISQUE AJUSTAGE / DISCO DISTANZA / ARANDELA DISTANCIADORA
		32	946969 00000	946930-00000	STIFTSCHRAUBE / STUD / PRISONNIER / L'ASTA A VITE / ESPÁRRAGO
		36	945129 00000	945237-00000	SECHSKANTSCHRAUBE / HEX-HEAD SCREW / VIS HEXAGONALE / VITE ESAGONALE / TORNILLO DE CABEZA HEXAGONAL
		53	011400 22200		DISTANZSCHEIBE / DISTANCE-DISK / DISQUE AJUSTAGE / DISCO DISTANZA / ARANDELA DISTANCIADORA
		54	011402 52200		DISTANZSCHEIBE / DISTANCE-DISK / DISQUE AJUSTAGE / DISCO DISTANZA / ARANDELA DISTANCIADORA
		55	913110 01000		DICHTUNG / GASKET / JOINT / GUARNIZIONE / JUNTA
		401	004600 52200		FILTERGEHÄUSE / FILTER HOUSING / BOITE POUR FILTRE / CONTENITORE FILTRO / CARCASA DE FILTRO
		403	008901 52200		DICHTUNG / GASKET / JOINT / GUARNIZIONE / JUNTA
		404	008902 52200		DICHTUNG / GASKET / JOINT / GUARNIZIONE / JUNTA
		405	945376 00000		INNENSECHSKANTSCHRAUBE / SOCKET HEAD SCREW / VIS HEXAGONALE INTERNE / VITE ESAGONALE INTERNA / TORNILLO HEXAGONAL INTERIOR
		407	946973 00000		STIFTSCHRAUBE / STUD / PRISONNIER / L'ASTA A VITE / ESPÁRRAGO
		408	946975 00000		STIFTSCHRAUBE / STUD / PRISONNIER / L'ASTA A VITE / ESPÁRRAGO
		409	040203 52200		DECKEL / COVER / COUVERCLE / COPERCHIO / TAPA
		412	909510 00000		FILTERPATRONE / FILTER CARTRIDGE / CARTOUCHE FILTRANTE / CARTUCCIA FILTRO / CARTUCHO DE FILTRO
		413	921501 50000		HANDGRIFF / HANDLE / POIGNEE / MANETTA / EMPUÑADURA
		502	945345 00000		INNENSECHSKANTSCHRAUBE / SOCKET HEAD SCREW / VIS HEXAGONALE INTERNE / VITE ESAGONALE INTERNA / TORNILLO HEXAGONAL INTERIOR
		507	060301 52200		ANSCHLUSSSTÜCK / MANIFOLD / BOÎTE DE DÉRIVATION / SCATOLA DI CONNESSIONE / CAJA DE CONEXIÓN
		509	008903 22200		DICHTUNG / GASKET / JOINT / GUARNIZIONE / JUNTA
	510	945330 04000		INNENSECHSKANTSCHRAUBE / SOCKET HEAD SCREW / VIS HEXAGONALE INTERNE / VITE ESAGONALE INTERNA / TORNILLO HEXAGONAL INTERIOR	
	512	007900 22200		DICHTUNG / GASKET / JOINT / GUARNIZIONE / JUNTA	
	513	560201 22200		KÜHLER / COOLER / REFRROIDISSEUR / RAFFREDDATORE / REFRIGERADOR	
④ VTLF 2.200/6 VTLF 2.250/6 - Korrosionsschutz - corrosion protection - protection contre la corrosion - protezione anti-corrosione - protección contra la corrosión		101	000111 52200	000100-52200	GEHÄUSE / PUMP BODY / CORP DE POMPE / CARCASSA / CARCASA
		105	020011 22200	020000-22200	KOLBEN / ROTOR / PISTON / ROTORE / ÉMBOLO
		111	000711 52200	000700-52200	SEITENDECKEL / LID LATERAL / COUVERCLE LATÉRAL / COPERCHIO LATERALE / TAPA LATERAL
		112	000811 52200	000800-52200	SEITENDECKEL / LID LATERAL / COUVERCLE LATÉRAL / COPERCHIO LATERALE / TAPA LATERAL
		203	909596 00000	909542-00000	FILTERPATRONE / FILTER CARTRIDGE / CARTOUCHE FILTRANTE / CARTUCCIA FILTRO / CARTUCHO DE FILTRO

²⁾ variantenabhängige Bauteile / variant-dependent components / composants variante-dependantes / componenti variante-dispendenti / componentes variante-dependientes

³⁾ nur bei Verwendung der Motorvariante 42969601300000CT erforderlich / only necessary when using the engine variant 42969601300000CT / uniquement nécessaire lors de l'utilisation de la variante du moteur 42969601300000CT / necessario solo quando si utilizza la variante del motore 42969601300000CT / solo es necesario cuando se utiliza la variante del motor 42969601300000CT

()TLF 2.200 ()TLF 2.250 ()TLF 2.360	Variante 	Pos. ²⁾	Bestell Nr. / Ident No. / No. Identification / No. Identificazione / No. De pedido		Beschreibung / Description / Designation / Designazione / Desripcion
					
⑤ VTLF 2.250/0-4XX - mit Frequenzumrichter - with frequency convertor - avec convertisseur de fréquence - con convertitore di frequenza - con convertidor de frecuencia		701	796302 51115		7,5KW - FREQUENZUMFORMER / FREQUENCY CONVERTOR / CONVERTISSEUR DE FRÉQUENCE / CONVERTITORE DI FREQUENZA / CONVERTIDOR DE FRECUENCIA
		702 ³⁾	003602 52115		ADAPTERPLATTE / ADAPTER PLATE / PLATINE D'ADAPTION / ADATTATORE PIATTO / PLACA ADAPTADORA
		703 ³⁾	025500 24000		DICHTUNG / GASKET / JOINT / GUARNIZIONE / JUNTA
		704 ³⁾	945320 00000		INNENSECHSKANTSCHRAUBE / SOCKET HEAD SCREW / VIS HEXAGONALE INTERNE / VITE ESAGONALE INTERNA / TORNILLO HEXAGONAL INTERIOR
⑥ DTLF 2.250/0-4XX - mit Frequenzumrichter - with frequency convertor - avec convertisseur de fréquence - con convertitore di frequenza - con convertidor de frecuencia		701	769312 41101		15KW - FREQUENZUMFORMER / FREQUENCY CONVERTOR / CONVERTISSEUR DE FRÉQUENCE / CONVERTITORE DI FREQUENZA / CONVERTIDOR DE FRECUENCIA
		702	003602 83111		ADAPTERPLATTE / ADAPTER PLATE / PLATINE D'ADAPTION / ADATTATORE PIATTO / PLACA ADAPTADORA
		704	945377 00000		INNENSECHSKANTSCHRAUBE / SOCKET HEAD SCREW / VIS HEXAGONALE INTERNE / VITE ESAGONALE INTERNA / TORNILLO HEXAGONAL INTERIOR

²⁾ variantenabhängige Bauteile / variant-dependent components / composants variante-dependantes / componenti variante-dispendenti / componentes variante-dependientes

³⁾ nur bei Verwendung der Motorvariante 42969601300000CT erforderlich / only necessary when using the engine variant 42969601300000CT / uniquement nécessaire lors de l'utilisation de la variante du moteur 42969601300000CT / necessario solo quando si utilizza la variante del motore 42969601300000CT / solo es necesario cuando se utiliza la variante del motor 42969601300000CT