

**T 4.25DSK**  
**T 4.25DV**  
**T 4.40DSK**  
**T 4.40DV**

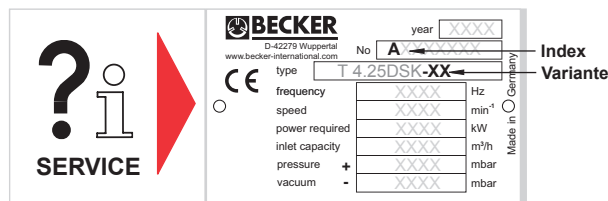
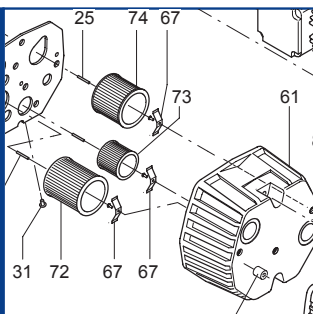

**Ersatzteilliste**  
**Spare parts list**  
**Liste de pièces de rechange**  
**Listino pezzi di ricambio**  
**Lista de piezas de recambio**  
**Lista de peças sobresselentes**  
**Reserveonderdelenlijst**  
**Atsarginių dalių sąrašas**  
**Varuosad nimekirja**  
**Rezerves daļu saraksts**

**Reservedelsliste**  
**Reservdelslista**  
**Varaosuettelo**  
**Reservedelsliste**  
**Wykaz części zamiennych**  
**Tartalékalkatrész lista**  
**Seznam náhradních dílů**  
**Seznam nadomestnih delov**  
**Zoznam náhradných dielov**  
**Rezervni dijelovi popis**

**Lista pieselor de schimb**  
**Páirteanna spártha liosta**  
**Κατάλογος ανταλλακτικών**  
**Yedek parça listesi**  
**Списък на резервните части**  
**Перечень запасных частей**  
**スペアパーツリスト**  
**예비 부품 목록**  
**备用零件目录**

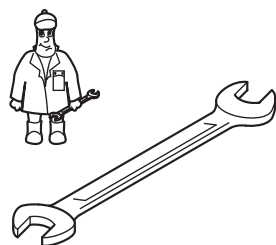

Pos.	Menge <sup>2)</sup> Quantity Quantité Quantità Cantidad	Bestell-Nr. Ident No. No. Identification No. Identificazione No. de pedido	Bezeichnung Description Designation Designazione Descripción
<b>T 4.25DSK</b>			
24	SATZ/KIT	901349 00007	Schieber, Rotor Vane, Palette, Empujador
72	1	909505 00000	Filterpatrone, Filter cartridge, Cartouche Filtrante, Cartuccia filtro, Cartucho de filtro
73	1	909518 00000	
74	1	909529 00000	
<b>T 4.40DSK</b>			
24	SATZ/KIT	901352 00007	Schieber, Rotor Vane, Palette, Empujador
72	1	909505 00000	Filterpatrone, Filter cartridge, Cartouche Filtrante, Cartuccia filtro, Cartucho de filtro
73	1	909518 00000	
74	1	909529 00000	

<sup>2)</sup> erforderliche Bestellmenge / necessary order quantity / quantité nécessaire / quantità di ordinazione necessari / cantidad necesario



Authorized Dealer  
 1.800.229.0009  
 sales@updateltd.com  
 www.updateltd.com



T 4.25DSK  
T 4.40DSK

Standard



Variante



T 4.25DSK/XX

- ①
- 1~ Einphasenwechselstrom
- 1~ single-phase AC

T 4.25 DV

- ②
- 3~ ohne Kühler
- 3~ without cooler

T 4.40DSK/XX

- ③
- 1~ Einphasenwechselstrom
- 1~ single-phase AC

- ④ /-34
- 3~ mit vergrößerter Exzentrizität
- 3~ with enlarged eccentricity

T 4.40 DV

- ⑤
- 3~ ohne Kühler
- 3~ without cooler

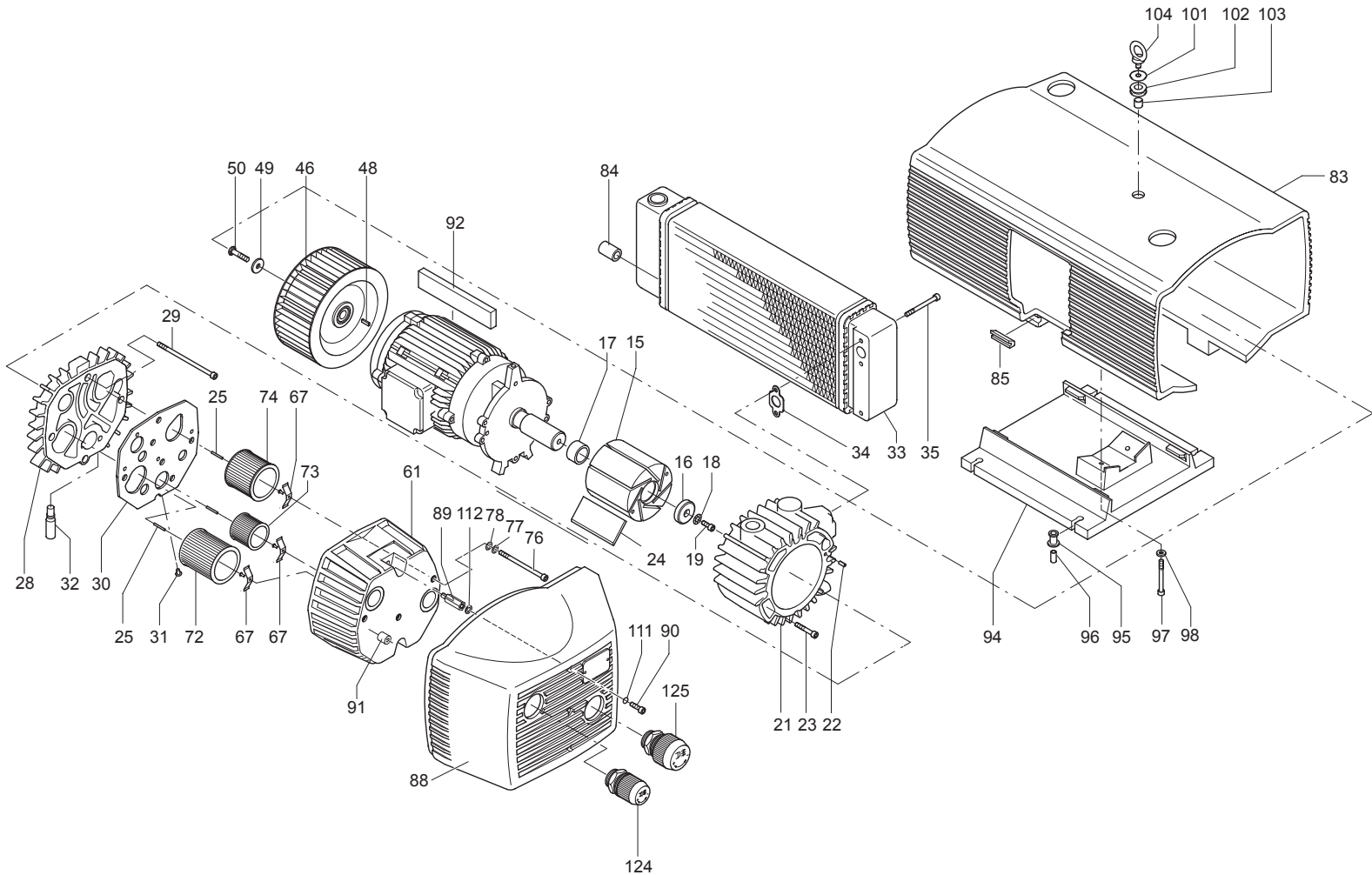

SERVICE ? i

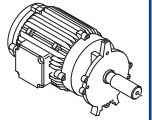

C = ?  $\mu$ F  
U = ? V

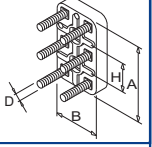
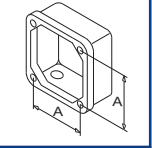
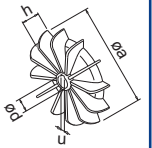
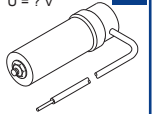

A INDEX	Pos.	Bestell Nr.	Beschreibung	
T 4.25DSK	15	020000 16400	KOLBEN	
	16	016800 16500	SPANNSCHEIBE	
	17	911012 00000	STAR-TOLERANZRING	
	18	949203 00000	ZAHNSCHEIBE	
	19	945320 00000	INNENSECHSKANTSCHRAUBE	
	21	000100 27500	GEHÄUSE	
	22	951806 00000	SPANNHÜLSE	
	23	945320 00000	INNENSECHSKANTSCHRAUBE	
	24	901349 00007	<b>SCHIEBER, KOHLE (SATZ)</b>	
	25	952009 00000	SPANNHÜLSE	
	28	000700 27600	SEITENDECKEL	
	29	945373 00000	INNENSECHSKANTSCHRAUBE	
	30	008900 16500	DICHTUNG	
	31	948763 00000	KERBNAGEL	
	32	953114 00000	SCHALLDÄMPFERDÜSE	
	33	560200 27500	KÜHLER	
	34	005700 27600	DICHTUNG	
	35	945325 00000	INNENSECHSKANTSCHRAUBE	
	46	502300 16400	VENTILATOR	
	48	947713 00000	PASSFEDER	
	49	949454 00000	UNTERLEGSCHNEIBE	
	50	901804 00000	WELLENENDSCHRAUBE	
	61	004803 27600	FILTERDECKEL	
	67	009000 16300	ANPRESSFEDER	
	72	909505 00000	<b>FILTERPATRONE (1x)<sup>1)</sup></b>	
	73	909518 00000	<b>FILTERPATRONE (1x)<sup>1)</sup></b>	
	74	909529 00000	<b>FILTERPATRONE (1x)<sup>1)</sup></b>	
	76	945373 00000	INNENSECHSKANTSCHRAUBE	
	77	948021 00000	DICHTRING	
	78	913161 00000	O-RING	
	83	006800 27500	GERÄTEHAUBE	
	84	742609 01000	SCHLAUCH	
	85	951920 00000	GUMMIFORMTEIL	
	88	006803 27600	GERÄTEHAUBE	
	89	068000 27500	DISTANZSTÜCK	
	90	945320 00000	INNENSECHSKANTSCHRAUBE	
	91	951922 00000	GUMMIFORMTEIL	
	92	964108 00000	KANTENSCHUTZ	
	94	015100 27600	FUSS	
	95	951921 00000	GUMMIFORMTEIL	
	96	068000 27600	DISTANZSTÜCK	
	97	945328 00000	INNENSECHSKANTSCHRAUBE	
	98	949451 00000	UNTERLEGSCHNEIBE	
	101	833903 99597	VENTILTÄLLER	
	102	951906 00000	KABELTÜLLE	
	103	068002 16500	DISTANZROHR	
	104	548800 16300	RINGSCHRAUBE	
	111	913161 00000	O-RING	
	112	741300 27600	GUMMISCHEIBE	
	124	736000 99613	VAKUUMREGULIERVENTIL	
	125	728002 99611	DRUCKREGULIERVENTIL	

<sup>1)</sup>erforderliche Bestellmenge / Wartung

A INDEX	Pos.	Bestell Nr.	Beschreibung	
T 4.40DSK	15	020000 16500	KOLBEN	
	16	016800 16500	SPANNSCHEIBE	
	17	911008 00000	STAR-TOLERANZRING	
	18	949203 00000	ZAHNSCHEIBE	
	19	945320 00000	INNENSECHSKANTSCHRAUBE	
	21	000100 27600	GEHÄUSE	
	22	951806 00000	SPANNHÜLSE	
	23	945322 00000	INNENSECHSKANTSCHRAUBE	
	24	901352 00007	<b>SCHIEBER, KOHLE (SATZ)</b>	
	25	952009 00000	SPANNHÜLSE	
	28	000700 27600	SEITENDECKEL	
	29	945374 00000	INNENSECHSKANTSCHRAUBE	
	30	008900 16500	DICHTUNG	
	31	948763 00000	KERBNAGEL	
	32	953114 00000	SCHALLDÄMPFERDÜSE	
	33	560200 27600	KÜHLER	
	34	005700 27600	DICHTUNG	
	35	945325 00000	INNENSECHSKANTSCHRAUBE	
	46	902300 27600	VENTILATOR	
	48	947713 00000	PASSFEDER	
	49	949454 00000	UNTERLEGSCHNEIBE	
	50	901804 00000	WELLENENDSCHRAUBE	
	61	004803 27600	FILTERDECKEL	
	67	009000 16300	ANPRESSFEDER	
	72	909505 00000	<b>FILTERPATRONE (1x)<sup>1)</sup></b>	
	73	909518 00000	<b>FILTERPATRONE (1x)<sup>1)</sup></b>	
	74	909529 00000	<b>FILTERPATRONE (1x)<sup>1)</sup></b>	
	76	945373 00000	INNENSECHSKANTSCHRAUBE	
	77	948021 00000	DICHTRING	
	78	913161 00000	O-RING	
	83	006800 27600	GERÄTEHAUBE	
	84	742609 01000	SCHLAUCH	
	85	951920 00000	GUMMIFORMTEIL	
	88	006803 27600	GERÄTEHAUBE	
	89	068000 27500	DISTANZSTÜCK	
	90	945320 00000	INNENSECHSKANTSCHRAUBE	
	91	951922 00000	GUMMIFORMTEIL	
	92	964108 00000	KANTENSCHUTZ	
	94	015100 27600	FUSS	
	95	951921 00000	GUMMIFORMTEIL	
	96	068000 27600	DISTANZSTÜCK	
	97	945328 00000	INNENSECHSKANTSCHRAUBE	
	98	949451 00000	UNTERLEGSCHNEIBE	
	101	833903 99597	VENTILTÄLLER	
	102	951906 00000	KABELTÜLLE	
	103	068002 16500	DISTANZROHR	
	104	548800 16300	RINGSCHRAUBE	
	111	913161 00000	O-RING	
	112	741300 27600	GUMMISCHEIBE	
	124	736000 99613	VAKUUMREGULIERVENTIL	
	125	728002 99611	DRUCKREGULIERVENTIL	

<sup>1)</sup>erforderliche Bestellmenge / Wartung

A INDEX	Pos.	Ident No.	Description	
T 4.25DSK	15	020000 16400	ROTOR	
	16	016800 16500	CLAMPING DISC	
	17	911012 00000	STAR-TOLERANCE-RING	
	18	949203 00000	TOOTHED SPRING WASHER	
	19	945320 00000	SOCKET HEAD SCREW	
	21	000100 27500	PUMP BODY	
	22	951806 00000	LOCATING PEG	
	23	945320 00000	SOCKET HEAD SCREW	
	24	901349 00007	<b>CARBON VANES (KIT)</b>	
	25	952009 00000	LOCATING PEG	
	28	000700 27600	LID	
	29	945373 00000	SOCKET HEAD SCREW	
	30	008900 16500	GASKET	
	31	948763 00000	SLOTTED PIN	
	32	953114 00000	NOZZLE	
	33	560200 27500	COOLER	
	34	005700 27600	GASKET	
	35	945325 00000	SOCKET HEAD SCREW	
	46	502300 16400	FAN	
	48	947713 00000	KEY	
	49	949454 00000	WASHER	
	50	901804 00000	SHAFT END BOLD	
	61	004803 27600	FILTER COVER	
	67	009000 16300	LEAF SPRING	
	72	909505 00000	<b>FILTER CARTRIDGE (1x)<sup>1)</sup></b>	
	73	909518 00000	<b>FILTER CARTRIDGE (1x)<sup>1)</sup></b>	
	74	909529 00000	<b>FILTER CARTRIDGE (1x)<sup>1)</sup></b>	
	76	945373 00000	SOCKET HEAD SCREW	
	77	948021 00000	SEALING RING	
	78	913161 00000	O-RING	
	83	006800 27500	PROTECTING HOOD	
	84	742609 01000	TUBE FLEXIBLE	
	85	951920 00000	RUBBER ELEMENT	
	88	006803 27600	PROTECTING HOOD	
	89	068000 27500	SPACER	
	90	945320 00000	SOCKET HEAD SCREW	
	91	951922 00000	RUBBER ELEMENT	
	92	964108 00000	EDGE PROTECTION	
	94	015100 27600	FOOT	
	95	951921 00000	RUBBER ELEMENT	
	96	068000 27600	SPACING COLLAR	
	97	945328 00000	SOCKET HEAD SCREW	
	98	949451 00000	WASHER	
	101	833903 99597	VALVE DISC	
	102	951906 00000	RUBBER BUSHING	
	103	068002 16500	SPACER TUBE	
	104	548800 16300	RING SCREW	
	111	913161 00000	O-RING	
	112	741300 27600	RUBBER DISC	
	124	736000 99613	VACUUM REGULATING VALVE	
	125	728002 99611	PRESSURE REGULATING VALVE	

<sup>1)</sup> necessary order quantity / maintenance

A INDEX	Pos.	Ident No.	Description	
T 4.40DSK	15	020000 16500	ROTOR	
	16	016800 16500	CLAMPING DISC	
	17	911008 00000	STAR-TOLERANCE-RING	
	18	949203 00000	TOOTHED SPRING WASHER	
	19	945320 00000	SOCKET HEAD SCREW	
	21	000100 27600	PUMP BODY	
	22	951806 00000	LOCATING PEG	
	23	945322 00000	SOCKET HEAD SCREW	
	24	901352 00007	<b>CARBON VANES (KIT)</b>	
	25	952009 00000	LOCATING PEG	
	28	000700 27600	LID	
	29	945374 00000	SOCKET HEAD SCREW	
	30	008900 16500	GASKET	
	31	948763 00000	SLOTTED PIN	
	32	953114 00000	NOZZLE	
	33	560200 27600	COOLER	
	34	005700 27600	GASKET	
	35	945325 00000	SOCKET HEAD SCREW	
	46	902300 27600	FAN	
	48	947713 00000	KEY	
	49	949454 00000	WASHER	
	50	901804 00000	SHAFT END BOLD	
	61	004803 27600	FILTER COVER	
	67	009000 16300	LEAF SPRING	
	72	909505 00000	<b>FILTER CARTRIDGE (1x)<sup>1)</sup></b>	
	73	909518 00000	<b>FILTER CARTRIDGE (1x)<sup>1)</sup></b>	
	74	909529 00000	<b>FILTER CARTRIDGE (1x)<sup>1)</sup></b>	
	76	945373 00000	SOCKET HEAD SCREW	
	77	948021 00000	SEALING RING	
	78	913161 00000	O-RING	
	83	006800 27600	PROTECTING HOOD	
	84	742609 01000	TUBE FLEXIBLE	
	85	951920 00000	RUBBER ELEMENT	
	88	006803 27600	PROTECTING HOOD	
	89	068000 27500	SPACER	
	90	945320 00000	SOCKET HEAD SCREW	
	91	951922 00000	RUBBER ELEMENT	
	92	964108 00000	EDGE PROTECTION	
	94	015100 27600	FOOT	
	95	951921 00000	RUBBER ELEMENT	
	96	068000 27600	SPACING COLLAR	
	97	945328 00000	SOCKET HEAD SCREW	
	98	949451 00000	WASHER	
	101	833903 99597	VALVE DISC	
	102	951906 00000	RUBBER BUSHING	
	103	068002 16500	SPACER TUBE	
	104	548800 16300	RING SCREW	
	111	913161 00000	O-RING	
	112	741300 27600	RUBBER DISC	
	124	736000 99613	VACUUM REGULATING VALVE	
	125	728002 99611	PRESSURE REGULATING VALVE	

<sup>1)</sup> necessary order quantity / maintenance

A INDICE	Pos.	No. Identification	Designation	FR	
T 4.25DSK	15	020000 16400	PISTON		
	16	016800 16500	DISQUE DE SERRAGE		
	17	911012 00000	BAGUE STAR		
	18	949203 00000	DENT DISQUE		
	19	945320 00000	VIS HEXAGONALE INTERNE		
	21	000100 27500	CORP DE POMPE		
	22	951806 00000	DOUILLE DE ETRAGE		
	23	945320 00000	VIS HEXAGONALE INTERNE		
	24	901349 00007	PALETTE DE CHARBON (KIT)		
	25	952009 00000	DOVILLE DE ETRAGE		
	28	000700 27600	COUVERCLE		
	29	945373 00000	VIS HEXAGONALE INTERNE		
	30	008900 16500	JOINT		
	31	948763 00000	GOUPILLE A ENCOCHE		
	32	953114 00000	BUSE		
	33	560200 27500	REFROIDISSEUR		
	34	005700 27600	JOINT		
	35	945325 00000	VIS HEXAGONALE INTERNE		
	46	502300 16400	VENTILATEUR		
	48	947713 00000	CLAVETTE		
	49	949454 00000	RONDELLE		
	50	901804 00000	VIS BOUT D'ARBRE		
	61	004803 27600	COUVERCLE DU FILTRE		
	67	009000 16300	RESSORT-JAME		
	72	909505 00000	CARTOUCHE FILTRANTE (1x) <sup>1)</sup>		
	73	909518 00000	CARTOUCHE FILTRANTE (1x) <sup>1)</sup>		
	74	909529 00000	CARTOUCHE FILTRANTE (1x) <sup>1)</sup>		
	76	945373 00000	VIS HEXAGONALE INTERNE		
	77	948021 00000	JOINT		
	78	913161 00000	ANNEAU-O		
	83	006800 27500	CARTER PROTECTEUR		
	84	742609 01000	TUBE FLEXIBLE		
	85	951920 00000	ELEMENT EN CAOUTCHOUC		
	88	006803 27600	CARTER PROTECTEUR		
	89	068000 27500	ENTRETOISE		
	90	945320 00000	VIS HEXAGONALE INTERNE		
	91	951922 00000	ELEMENT EN CAOUTCHOUC		
	92	964108 00000	PROTECTION D'ARETE		
	94	015100 27600	PIED		
	95	951921 00000	ELEMENT EN CAOUTCHOUC		
	96	068000 27600	DONILLE D'ECARMENT		
	97	945328 00000	VIS HEXAGONALE INTERNE		
	98	949451 00000	RONDELLE		
	101	833903 99597	PLATEAU DE SOUPAPE		
	102	951906 00000	PROTECTION EN CAOUTCHOUC		
	103	068002 16500	TUBE D'ECARTEMENT		
	104	548800 16300	PITON		
	111	913161 00000	ANNEAU-O		
	112	741300 27600	RONDELLE DE CAOUTCHOUC		
	124	736000 99613	SOUPAPE REGLAGE VIDE		
	125	728002 99611	SOUPAPE REGLAGE PRESSION		

<sup>1)</sup> quantité nécessaire / entretien

A INDICE	Pos.	No. Identification	Designation	FR	
T 4.40DSK	15	020000 16500	PISTON		
	16	016800 16500	DISQUE DE SERRAGE		
	17	911008 00000	BAGUE STAR		
	18	949203 00000	DENT DISQUE		
	19	945320 00000	VIS HEXAGONALE INTERNE		
	21	000100 27600	CORP DE POMPE		
	22	951806 00000	DOUILLE DE ETRAGE		
	23	945322 00000	VIS HEXAGONALE INTERNE		
	24	901352 00007	PALETTE DE CHARBON (KIT)		
	25	952009 00000	DOVILLE DE ETRAGE		
	28	000700 27600	COUVERCLE		
	29	945374 00000	VIS HEXAGONALE INTERNE		
	30	008900 16500	JOINT		
	31	948763 00000	GOUPILLE A ENCOCHE		
	32	953114 00000	BUSE		
	33	560200 27600	REFROIDISSEUR		
	34	005700 27600	JOINT		
	35	945325 00000	VIS HEXAGONALE INTERNE		
	46	902300 27600	VENTILATEUR		
	48	947713 00000	CLAVETTE		
	49	949454 00000	RONDELLE		
	50	901804 00000	VIS BOUT D'ARBRE		
	61	004803 27600	COUVERCLE DU FILTRE		
	67	009000 16300	RESSORT-JAME		
	72	909505 00000	CARTOUCHE FILTRANTE (1x) <sup>1)</sup>		
	73	909518 00000	CARTOUCHE FILTRANTE (1x) <sup>1)</sup>		
	74	909529 00000	CARTOUCHE FILTRANTE (1x) <sup>1)</sup>		
	76	945373 00000	VIS HEXAGONALE INTERNE		
	77	948021 00000	JOINT		
	78	913161 00000	ANNEAU-O		
	83	006800 27600	CARTER PROTECTEUR		
	84	742609 01000	TUBE FLEXIBLE		
	85	951920 00000	ELEMENT EN CAOUTCHOUC		
	88	006803 27600	CARTER PROTECTEUR		
	89	068000 27500	ENTRETOISE		
	90	945320 00000	VIS HEXAGONALE INTERNE		
	91	951922 00000	ELEMENT EN CAOUTCHOUC		
	92	964108 00000	PROTECTION D'ARETE		
	94	015100 27600	PIED		
	95	951921 00000	ELEMENT EN CAOUTCHOUC		
	96	068000 27600	DONILLE D'ECARMENT		
	97	945328 00000	VIS HEXAGONALE INTERNE		
	98	949451 00000	RONDELLE		
	101	833903 99597	PLATEAU DE SOUPAPE		
	102	951906 00000	PROTECTION EN CAOUTCHOUC		
	103	068002 16500	TUBE D'ECARTEMENT		
	104	548800 16300	PITON		
	111	913161 00000	ANNEAU-O		
	112	741300 27600	RONDELLE DE CAOUTCHOUC		
	124	736000 99613	SOUPAPE REGLAGE VIDE		
	125	728002 99611	SOUPAPE REGLAGE PRESSION		

<sup>1)</sup> quantité nécessaire / entretien

A INDICE	Pos.	No. Identificazione	Designazione		
T 4.25DSK	15	020000 16400	ROTORE		
	16	016800 16500	DISCO DI FISSAGGIO		
	17	911012 00000	STAR-ANNELLO TOLLERANZA		
	18	949203 00000	DISCO A DENTE		
	19	945320 00000	VITE ESAGONALE INTERNA		
	21	000100 27500	CARCASSA		
	22	951806 00000	SPINE DI RISCONTRO		
	23	945320 00000	VITE ESAGONALE INTERNA		
	24	901349 00007	PALETTE DI CHARBONE (KIT)		
	25	952009 00000	SPINE DI RISCONTRO		
	28	000700 27600	COPERCHIO		
	29	945373 00000	VITE ESAGONALE INTERNA		
	30	008900 16500	GUARNIZIONE		
	31	948763 00000	PERNO		
	32	953114 00000	UGGELLO		
	33	560200 27500	RAFFREDDATORE		
	34	005700 27600	GUARNIZIONE		
	35	945325 00000	VITE ESAGONALE INTERNA		
	46	502300 16400	VENTILATORE		
	48	947713 00000	CHIAVETTA		
	49	949454 00000	RONDELLA		
	50	901804 00000	VITE DI CHIUSURA ALBERO		
	61	004803 27600	COPERCHIO FILTRO		
	67	009000 16300	MOLLA		
	72	909505 00000	CARTUCCIA FILTRO (1x) <sup>1)</sup>		
	73	909518 00000	CARTUCCIA FILTRO (1x) <sup>1)</sup>		
	74	909529 00000	CARTUCCIA FILTRO (1x) <sup>1)</sup>		
	76	945373 00000	VITE ESAGONALE INTERNA		
	77	948021 00000	ANELLO GUARNIZIONE		
	78	913161 00000	ANELLO-O		
	83	006800 27500	CARTER DI PROTEZIONE		
	84	742609 01000	TUBO FLESSIBILE		
	85	951920 00000	ELEMENTO IN GOMMA		
	88	006803 27600	CARTER DI PROTEZIONE		
	89	068000 27500	SPAZIATORE		
	90	945320 00000	VITE ESAGONALE INTERNA		
	91	951922 00000	ELEMENTO IN GOMMA		
	92	964108 00000	LISTELLO DI PROTEZIONE		
	94	015100 27600	PIEDE		
	95	951921 00000	ELEMENTO IN GOMMA		
	96	068000 27600	BOCCOLA DISTANZIATRICE		
	97	945328 00000	VITE ESAGONALE INTERNA		
	98	949451 00000	RONDELLA		
	101	833903 99597	PIATELLO DELLA VALVOLA		
	102	951906 00000	PROTEZIONE IN GOMMA		
	103	068002 16500	TUBO DISTANZA		
	104	548800 16300	GANCIO		
	111	913161 00000	ANELLO-O		
	112	741300 27600	RONDELLA IN GOMMA		
	124	736000 99613	VALVOLA REGOLARE VUOTO		
	125	728002 99611	VALVOLA REGOLARE PRESSIONE		

<sup>1)</sup> quantità di ordinazione necessari / manutenzione

A INDICE	Pos.	No. Identificazione	Designazione		
T 4.40DSK	15	020000 16500	ROTORE		
	16	016800 16500	DISCO DI FISSAGGIO		
	17	911008 00000	STAR-ANNELLO TOLLERANZA		
	18	949203 00000	DISCO A DENTE		
	19	945320 00000	VITE ESAGONALE INTERNA		
	21	000100 27600	CARCASSA		
	22	951806 00000	SPINE DI RISCONTRO		
	23	945322 00000	VITE ESAGONALE INTERNA		
	24	901352 00007	PALETTE DI CHARBONE (KIT)		
	25	952009 00000	SPINE DI RISCONTRO		
	28	000700 27600	COPERCHIO		
	29	945374 00000	VITE ESAGONALE INTERNA		
	30	008900 16500	GUARNIZIONE		
	31	948763 00000	PERNO		
	32	953114 00000	UGGELLO		
	33	560200 27600	RAFFREDDATORE		
	34	005700 27600	GUARNIZIONE		
	35	945325 00000	VITE ESAGONALE INTERNA		
	46	902300 27600	VENTILATORE		
	48	947713 00000	CHIAVETTA		
	49	949454 00000	RONDELLA		
	50	901804 00000	VITE DI CHIUSURA ALBERO		
	61	004803 27600	COPERCHIO FILTRO		
	67	009000 16300	MOLLA		
	72	909505 00000	CARTUCCIA FILTRO (1x) <sup>1)</sup>		
	73	909518 00000	CARTUCCIA FILTRO (1x) <sup>1)</sup>		
	74	909529 00000	CARTUCCIA FILTRO (1x) <sup>1)</sup>		
	76	945373 00000	VITE ESAGONALE INTERNA		
	77	948021 00000	ANELLO GUARNIZIONE		
	78	913161 00000	ANELLO-O		
	83	006800 27600	CARTER DI PROTEZIONE		
	84	742609 01000	TUBO FLESSIBILE		
	85	951920 00000	ELEMENTO IN GOMMA		
	88	006803 27600	CARTER DI PROTEZIONE		
	89	068000 27500	SPAZIATORE		
	90	945320 00000	VITE ESAGONALE INTERNA		
	91	951922 00000	ELEMENTO IN GOMMA		
	92	964108 00000	LISTELLO DI PROTEZIONE		
	94	015100 27600	PIEDE		
	95	951921 00000	ELEMENTO IN GOMMA		
	96	068000 27600	BOCCOLA DISTANZIATRICE		
	97	945328 00000	VITE ESAGONALE INTERNA		
	98	949451 00000	RONDELLA		
	101	833903 99597	PIATELLO DELLA VALVOLA		
	102	951906 00000	PROTEZIONE IN GOMMA		
	103	068002 16500	TUBO DISTANZA		
	104	548800 16300	GANCIO		
	111	913161 00000	ANELLO-O		
	112	741300 27600	RONDELLA IN GOMMA		
	124	736000 99613	VALVOLA REGOLARE VUOTO		
	125	728002 99611	VALVOLA REGOLARE PRESSIONE		

<sup>1)</sup> quantità di ordinazione necessari / manutenzione

A INDICE	Pos.	No. De pedido	Descripción	ES	
T 4.25DSK	15	020000 16400	ÉMBOLO		
	16	016800 16500	ARANDELA TENSORA		
	17	911012 00000	ANILLO DE TOLERANCIA STAR		
	18	949203 00000	POLEA DENTADA		
	19	945320 00000	TORNILLO HEXAGONAL INTERIOR		
	21	000100 27500	CARCASA		
	22	951806 00000	CASQUILLO TENSOR		
	23	945320 00000	TORNILLO HEXAGONAL INTERIOR		
	24	901349 00007	<b>EMPUJADOR DE CARBÓN (KIT)</b>		
	25	952009 00000	CASQUILLO TENSOR		
	28	000700 27600	TAPA LATERAL		
	29	945373 00000	TORNILLO HEXAGONAL INTERIOR		
	30	008900 16500	JUNTA		
	31	948763 00000	CLAVO ESTRIADO		
	32	953114 00000	TOBERA DE SILENCIADOR		
	33	560200 27500	REFRIGERADOR		
	34	005700 27600	JUNTA		
	35	945325 00000	TORNILLO HEXAGONAL INTERIOR		
	46	502300 16400	VENTILADOR		
	48	947713 00000	LENGÜETA DE AJUSTE		
	49	949454 00000	ARANDELA		
	50	901804 00000	TORNILLO TERMINAL DE ÁRBOL		
	61	004803 27600	TAPA DE FILTRO		
	67	009000 16300	MUELLE DE PRESIÓN		
	72	909505 00000	<b>CARTUCHO DE FILTRO (1x)<sup>1)</sup></b>		
	73	909518 00000	<b>CARTUCHO DE FILTRO (1x)<sup>1)</sup></b>		
	74	909529 00000	<b>CARTUCHO DE FILTRO (1x)<sup>1)</sup></b>		
	76	945373 00000	TORNILLO HEXAGONAL INTERIOR		
	77	948021 00000	ANILLO DE JUNTA		
	78	913161 00000	JUNTA TÓRICA		
	83	006800 27500	CAPERUZA DE APARATO		
	84	742609 01000	MANGUERA		
	85	951920 00000	PIEZA DE ORMA DE GOMA		
	88	006803 27600	CAPERUZA DE APARATO		
	89	068000 27500	PORTABOQUILLA		
	90	945320 00000	TORNILLO HEXAGONAL INTERIOR		
	91	951922 00000	PIEZA DE ORMA DE GOMA		
	92	964108 00000	PROTECCIÓN DE CANTOS		
	94	015100 27600	PIE		
	95	951921 00000	PIEZA DE ORMA DE GOMA		
	96	068000 27600	PIEZA DISTANCIADORA		
	97	945328 00000	TORNILLO HEXAGONAL INTERIOR		
	98	949451 00000	ARANDELA		
	101	833903 99597	PLATILLO DE VÁLVULA		
	102	951906 00000	BOQUILLA DE CABLE		
	103	068002 16500	TUBO DISTANCIADOR		
	104	548800 16300	TORNILLO DE CÁNCAMO		
	111	913161 00000	JUNTA TÓRICA		
	112	741300 27600	ARANDELA DE GOMA		
	124	736000 99613	VÁLVULA REGULADORA DE VACÍO		
	125	728002 99611	VÁLVULA REGULADORA DE PRESIÓN		

<sup>1)</sup> cantidad necesario / mantenimiento







A INDICE	Pos.	No. De pedido	Descripción	ES	
T 4.40DSK	15	020000 16500	ÉMBOLO		
	16	016800 16500	ARANDELA TENSORA		
	17	911008 00000	ANILLO DE TOLERANCIA STAR		
	18	949203 00000	POLEA DENTADA		
	19	945320 00000	TORNILLO HEXAGONAL INTERIOR		
	21	000100 27600	CARCASA		
	22	951806 00000	CASQUILLO TENSOR		
	23	945322 00000	TORNILLO HEXAGONAL INTERIOR		
	24	901352 00007	<b>EMPUJADOR DE CARBÓN (KIT)</b>		
	25	952009 00000	CASQUILLO TENSOR		
	28	000700 27600	TAPA LATERAL		
	29	945374 00000	TORNILLO HEXAGONAL INTERIOR		
	30	008900 16500	JUNTA		
	31	948763 00000	CLAVO ESTRIADO		
	32	953114 00000	TOBERA DE SILENCIADOR		
	33	560200 27600	REFRIGERADOR		
	34	005700 27600	JUNTA		
	35	945325 00000	TORNILLO HEXAGONAL INTERIOR		
	46	902300 27600	VENTILADOR		
	48	947713 00000	LENGÜETA DE AJUSTE		
	49	949454 00000	ARANDELA		
	50	901804 00000	TORNILLO TERMINAL DE ÁRBOL		
	61	004803 27600	TAPA DE FILTRO		
	67	009000 16300	MUELLE DE PRESIÓN		
	72	909505 00000	<b>CARTUCHO DE FILTRO (1x)<sup>1)</sup></b>		
	73	909518 00000	<b>CARTUCHO DE FILTRO (1x)<sup>1)</sup></b>		
	74	909529 00000	<b>CARTUCHO DE FILTRO (1x)<sup>1)</sup></b>		
	76	945373 00000	TORNILLO HEXAGONAL INTERIOR		
	77	948021 00000	ANILLO DE JUNTA		
	78	913161 00000	JUNTA TÓRICA		
	83	006800 27600	CAPERUZA DE APARATO		
	84	742609 01000	MANGUERA		
	85	951920 00000	PIEZA DE ORMA DE GOMA		
	88	006803 27600	CAPERUZA DE APARATO		
	89	068000 27500	PORTABOQUILLA		
	90	945320 00000	TORNILLO HEXAGONAL INTERIOR		
	91	951922 00000	PIEZA DE ORMA DE GOMA		
	92	964108 00000	PROTECCIÓN DE CANTOS		
	94	015100 27600	PIE		
	95	951921 00000	PIEZA DE ORMA DE GOMA		
	96	068000 27600	PIEZA DISTANCIADORA		
	97	945328 00000	TORNILLO HEXAGONAL INTERIOR		
	98	949451 00000	ARANDELA		
	101	833903 99597	PLATILLO DE VÁLVULA		
	102	951906 00000	BOQUILLA DE CABLE		
	103	068002 16500	TUBO DISTANCIADOR		
	104	548800 16300	TORNILLO DE CÁNCAMO		
	111	913161 00000	JUNTA TÓRICA		
	112	741300 27600	ARANDELA DE GOMA		
	124	736000 99613	VÁLVULA REGULADORA DE VACÍO		
	125	728002 99611	VÁLVULA REGULADORA DE PRESIÓN		

<sup>1)</sup> cantidad necesario / mantenimiento

T 4.25DSK T 4.40DSK	Variante 	Pos. <sup>2)</sup>	Bestell Nr. / Ident No. / No. Identification / No. Identificazione / No. De pedido		Beschreibung / Description / Designation / Designazione / Descripcion
<b>T 4.25 DSK</b>		8	964233 00000		WINKEL / BRACKET / COUDES / GOMITO / ÁNGULO
① 1~ Einphasenwechselstrom 1~ single-phase AC 1~ AC monophasé 1~ AC monofase 1~ AC monofásica		12	948766 00000		BLINDNIET / BLIND RIVET / RIVET AVEUGLIE / RIVETTO CIECO / REMACHE CIEGO
		13	742002 30000		KABEL / CABLE / CABLE / CAVO / CABLE
		83	006802 27500	006800-27500	HAUBE / PROTECTING HOOD / CARTER PROTECTEUR / CARTER DI PROTEZIONE / CAPERUZA
		94	015101 27600	015100-27600	FUSS / FOOT / PIED / PIEDE / PIE
<b>T 4.25 DV</b>		21	000100 16400	000100-27500	GEHÄUSE / PUMP BODY / CORP DE POMPE / CARCASSA / CARCASA
② 3~ ohne Kühler 3~ without cooler 3~ sans refroidisseur 3~ senza raffreddatore 3~ sin refrigerador		25		952009-00000	SPANNHÜLSE / LOCATING PEG / DOVILLE DE ETRAGE / SPINE DI RISCONTRO / CASQUILLO TENSOR
		28	000700 16500	000700-27600	SEITENDECKEL / LID / COUVERCLE / COPERCHIO / TAPA LATERAL
		31		948763-00000	BLINDNIET / BLIND RIVET / RIVET BORGNE / CHIDO CIECO / REMACHE DE CABEZA EMBUTIDA
		32		953114-00000	DÜSE / NOZZLE / GICLEUR / UGELLO / TOBERA
		33		560200-27500	KÜHLER / COOLER / REFRROIDISSEUR / RAFFREDDATORE / REFRIGERADOR
		34		005700-27600	DICHTUNG / GASKET / JOINT / GUARNIZIONE / JUNTA
		35		945325-00000	INNENSECHSKANTSCHRAUBE / SOCKET HEAD SCREW / VIS HEXAGONALE INTERNE / VITE ESAGONALE INTERNA / TORNILLO HEXAGONAL INTERIOR
		46	502301 16400	502300-16400	VENTILATOR / FAN / VENTILATEUR / VENTILATORE / VENTILADOR
		67		009000-16300	ANPRESSFEDER / LEAF SPRING / RESSORT-JAME / MOLLA / MUELLE DE PRESIÓN
		73		909518-00000	FILTERPATRONE / FILTER CARTRIDGE / CARTOUCHE FILTRANTE / CARTUCCIA FILTRO / CARTUCHO DE FILTRO
		83	006807 27500	006800-27500	GERÄTEHAUBE / PROTECTING HOOD / CARTER PROTECTEUR AVANT / CARTER DI PROTEZIONE / CAPERUZA FRONTAL
		84		742609-01000	SCHLAUCH / TUBE FLEXIBLE / TUBO FLESSIBILE / MANGUERA
		88	006802 27600	006803-27600	GERÄTEHAUBE / PROTECTING HOOD / CARTER PROTECTEUR AVANT / CARTER DI PROTEZIONE / CAPERUZA FRONTAL
		92	964111 00000	964108-00000	KANTENSCHUTZ / EDGE PROTECTION / PROTECTION D'ARETE / LISTELLO DI PROTEZIONE / PROTECCIÓN DE CANTOS
<b>T 4.40 DSK</b>		8	964233 00000		WINKEL / BRACKET / COUDES / GOMITO / ÁNGULO
③ 1~ Einphasenwechselstrom 1~ single-phase AC 1~ AC monophasé 1~ AC monofase 1~ AC monofásica		12	948766 00000		BLINDNIET / BLIND RIVET / RIVET AVEUGLIE / RIVETTO CIECO / REMACHE CIEGO
		13	742002 30000		KABEL / CABLE / CABLE / CAVO / CABLE
		83	006804 27600	006800-27600	HAUBE / PROTECTING HOOD / CARTER PROTECTEUR / CARTER DI PROTEZIONE / CAPERUZA
		94	015101 27600	015100-27600	FUSS / FOOT / PIED / PIEDE / PIE
④ /-34 3~ mit vergrößerter Exzentrizität 3~ with enlarged eccentricity 3~ avec excentricité agrandie 3~ con eccentricità ingrandita 3~ con excentricidad ampliada		21	000101 27600	000100-27600	GEHÄUSE / PUMP BODY / CORP DE POMPE / CARCASSA / CARCASA

<sup>2)</sup> variantenabhängige Bauteile / variant-dependent components / composants variante-dependantes / componenti variante-dispendenti / componentes variante-dependientes



T 4.25DSK T 4.40DSK	Variante 	Pos. <sup>2)</sup>	Bestell Nr. / Ident No. / No. Identification / No. Identificazione / No. De pedido		Beschreibung / Description / Designation / Designazione / Desripcion
			  	  	
<b>T 4.40 DV</b>		21	000100 16500	<del>000100 27600</del>	GEHÄUSE / PUMP BODY / CORP DE POMPE / CARCASSA / CARCASA
		25		<del>952009 00000</del>	SPANNHÜLSE / LOCATING PEG / DOVILLE DE ETRAGE / SPINE DI RISCONTRO / CASQUILLO TENSOR
		28	000700 16500	<del>000700 27600</del>	SEITENDECKEL / LID / COUVERCLE / COPERCHIO / TAPA LATERAL
		31		<del>948763 00000</del>	BLINDNIET / BLIND RIVET / RIVET BORGNE / CHIODO CIECO / REMACHE DE CABEZA EMBUTIDA
		32		<del>953114 00000</del>	DÜSE / NOZZLE / GICLEUR / UGELLO / TOBERA
		33		<del>560200 27600</del>	KÜHLER / COOLER / REFRROIDISSEUR / RAFFREDDATORE / REFRIGERADOR
		34		<del>005700 27600</del>	DICHTUNG / GASKET / JOINT / GUARNIZIONE / JUNTA
		35		<del>945325 00000</del>	INNENSECHSKANTSCHRAUBE / SOCKET HEAD SCREW / VITE HEXAGONALE INTERNE / VITE ESAGONALE INTERNA / TORNILLO HEXAGONAL INTERIOR
		46	902300 26200	<del>902300 27600</del>	VENTILATOR / FAN / VENTILATEUR / VENTILATORE / VENTILADOR
		67		<del>00900016300</del>	ANPRESSFEDER / LEAF SPRING / RESSORT-JAME / MOLLA / MUELLE DE PRESIÓN
		73		<del>909518 01000</del>	FILTERPATRONE / FILTER CARTRIDGE / CARTOUCHE FILTRANTE / CARTUCCIA FILTRO / CARTUCHO DE FILTRO
		83	006806 27600	<del>006800 27600</del>	GERÄTEHAUBE / PROTECTING HOOD / CARTER PROTECTEUR AVANT / CARTER DI PROTEZIONE / CAPERUZA FRONTAL
		84		<del>742600 01000</del>	SCHLAUCH / TUBE FLEXIBLE / TUBO FLESSIBILE / MANGUERA
		88	006802 27600	<del>006803 27600</del>	GERÄTEHAUBE / PROTECTING HOOD / CARTER PROTECTEUR AVANT / CARTER DI PROTEZIONE / CAPERUZA FRONTAL
		92	964109 00000	<del>964108 00000</del>	KANTENSCHUTZ / EDGE PROTECTION / PROTECTION D'ARETE / LISTELLO DI PROTEZIONE / PROTECCIÓN DE CANTOS

<sup>2)</sup> variantenabhängige Bauteile / variant-dependent components / composants variante-dependantes / componenti variante-dispendenti / componentes variante-dependientes