

DTLF / VTLF 2.400
DTLF / VTLF 2.500
DVTLF 2.500

BECKER
 D-42279 Wuppertal
 www.becker-international.com

No. () year XXXX

type VTLF 2.500-XX

frequency XXXX Hz
 speed XXXX min⁻¹
 power required XXXX kW
 inlet capacity XXXX m³/h
 pressure + XXXX mbar
 vacuum - XXXX mbar

Index Variante

Made in Germany

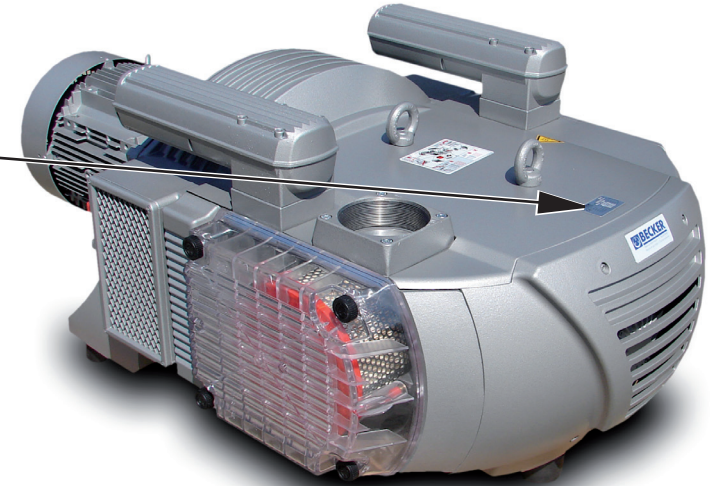

Ersatzteilliste
Spare parts list
Liste de pièces de rechange
Listino pezzi di ricambio
Lista de piezas de recambio
Lista de peças sobresselentes
Reserveonderdelenlijst
Atsarginių dalių sąrašas
Varuosad nimekirja
Rezerves daļu saraksts

Reservedelsliste
Reservdelslista
Varaosaluettelo
Reservedelsliste
Wykaz części zamiennych
Tartalékalkatrész lista
Seznam náhradních dílů
Seznam nadomestnih delov
Zoznam náhradných dielov
Rezervni dijelovi popis

Lista pieselor de schimb
Páirteanna spártha liosta
Κατάλογος ανταλλακτικών
Yedek parça listesi
Списък на резервните части
Перечень запасных частей
スペアパーツリスト
예비 부품 목록
备用零件目录

SERVICE

www.becker-international.com

Sales and service network

Authorized Dealer
 1.800.229.0009
sales@updateltd.com
www.updateltd.com

Wartung
Maintenance
Entretien
Manutenzione
Mantenimiento

Pos.	Menge ²⁾ Quantity Quantité Quantità Cantidad	Bestell-Nr. Ident No. No. Identification No. Identificazione No. de pedido	Bezeichnung Description Designation Designazione Descripción
□	1	549000 52300	Dichtungssatz, Complete set of seals, Jeu de joints, Kit di guarnizioni, Junta completa
126	SATZ/KIT	901373 01008	Schieber, Rotor Vane, Palette, Empujador
203	1	909597 00000	Filterpatrone (Papier), Filter cartridge (paper), Cartouche Filtrante (papier), Cartuccia filtro (carta), Cartucho de filtro (papel)
203	1 ³⁾	909510 20000	Filterpatrone (Polyester), Filter cartridge (polyester), Cartouche Filtrante (polyester), Cartuccia filtro (poliestere), Cartucho de filtro (poliéster)
520	1 ⁴⁾	909510 10000	Staubabscheider, Séparateur de poussière, Separatore di polveri, Separador de polvo

²⁾ erforderliche Bestellmenge / necessary order quantity / quantité nécessaire / quantità di ordinazione necessari / cantidad necesario
³⁾ nur für VTLF 2.X00/6 / only for VTLF 2.X00/6 / seulement pour VTLF 2.X00/6 / solo per VTLF 2.X00/6 / sólo para VTLF 2.X00/6
⁴⁾ nur für DTLF mit integriertem Staubabscheider / only for DTLF with integrated dust separator / seulement pour DTLF avec séparateur de poussière / solo per DTLF con separatore polvere / sólo para DTLF con separador de polvo

()TLF 2.400
()TLF 2.500

Standard

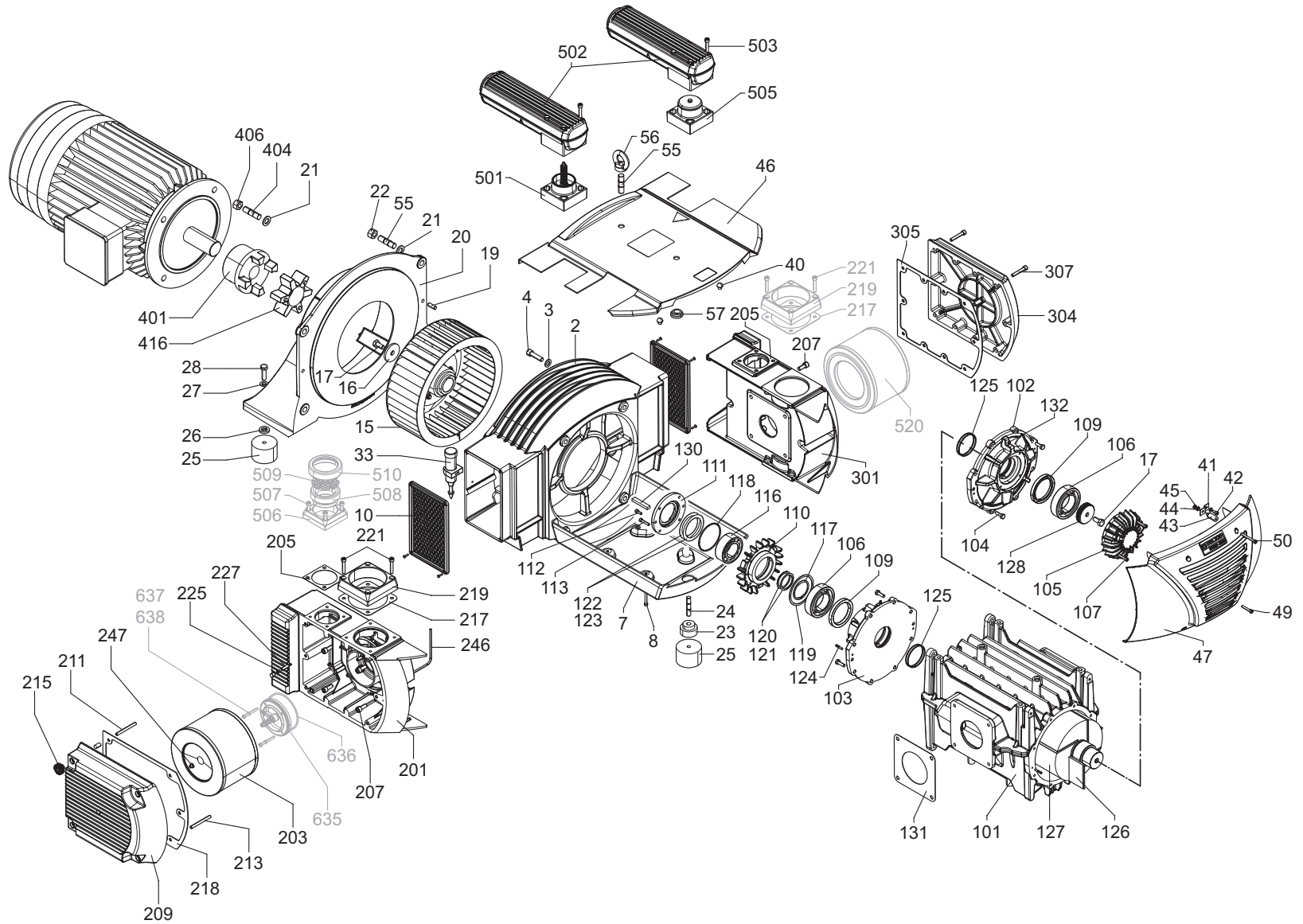

SERVICE ?

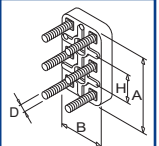
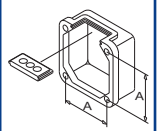
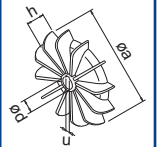
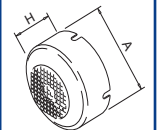
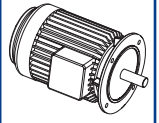

INDEX	Pos.	Bestell Nr.	Beschreibung	
() TLF 2.400-2.500	□	549000 52300	DICHTUNGSSATZ ¹⁾	
	2	053200 52300	LATERNE	
	3	947507 00000	UNTERLEGSCHEIBE	
	4	945369 00000	INNENSECHSKANTSCHRAUBE M12X45	
	7	918300 52300	HAUBE	
	8	901809 00000	WELLENENDSCHRAUBE M6X16	
	10	960700 52200	LÜFTERHAUBE	
	15	544500 22500	KUPPLUNG MIT VENTILATOR	
	16	949407 00000	UNTERLEGSCHEIBE	
	17	945270 00000	SECHSKANTSCHRAUBE	
	19	947654 00000	ZYLINDERSTIFT	
	20	014900 52300	MOTORFLANSCH	
	20	014901 52300	MOTORFLANSCH, > 18 KW	
	21	947509 00000	UNTERLEGSCHEIBE	
22	947109 00000	SECHSKANTMUTTER M16		
23	011400 52300	DISTANZSTÜCK		
24	951048 00000	STIFTSCHRAUBE M12X40		
25	741341 00000	GUMMIPUFFER		
26	950353 00000	KEGELPFANNE		
27	950356 00000	KUGELSCHEIBE		
28	945361 00000	SECHSKANTSCHRAUBE M12X40		
33	743303 00000	SPEZIALFETT (FETTPRESSE, 50g)		
40	951933 00000	GUMMIPUFFER		
41	002501 52300	WINKEL		
42	945318 00000	INNENSECHSKANTSCHRAUBE M6X12		
43	832800 21000	ABSTANDBOLZEN		
44	947504 00000	UNTERLEGSCHEIBE		
45	947104 02000	SECHSKANTMUTTER M6		
46	918301 52300	HAUBE (VTLF)		
46	918302 52300	HAUBE (DTLF)		
46	918303 52300	HAUBE (DVTLF)		
47	920800 52200	LUFTLEITHAUBE		
49	945323 00000	INNENSECHSKANTSCHRAUBE M6X35		
50	945324 00000	INNENSECHSKANTSCHRAUBE M6X55		
55	946962 00000	STIFTSCHRAUBE M16X40		
56	951605 00000	RINGMUTTER M16		
57	951919 00000	GUMMIPUFFER		
101	000100 52300	GEHÄUSE		
102	000700 52300	SEITENDECKEL		
103	000800 52300	SEITENDECKEL		
104	945230 00000	SECHSKANTSCHRAUBE M8X25		
105	001000 52300	LAGERDECKEL		
106	906614 00000	LAGER NU2211 E GBB30		
107	945328 00000	INNENSECHSKANTSCHRAUBE M6X50		
109	906580 00000	WELLENDICHTRING		
110	001101 52300	LAGERDECKEL		
111	001100 22500	LAGERDECKEL		
112	945319 00000	INNENSECHSKANTSCHRAUBE M6X16		
113	945322 00000	INNENSECHSKANTSCHRAUBE M6X30		
116	906636 00000	LAGER 3209 C3 GBB20		
117	948265 00000	SICHERUNGSRING		
118	913112 50100	DICHTRING		
119	917162 00000	AUSGLEICHSSCHEIBE		
120	911450 00000	DISTANZRING 45X55X0,025		
121	911451 00000	DISTANZRING 45X55X0,05		
122	911413 60000	DISTANZRING 65X85X0,025		
123	911413 70000	DISTANZRING 65X85X0,05		
124	948743 00000	KERBSTIFT 5X24		

INDEX	Pos.	Bestell Nr.	Beschreibung	
	125	917200 20000	DICHTUNG	
	126	901373 01008	SCHIEBER (SATZ) ²⁾	
	127	020000 52300	KOLBEN	
	128	068901 22500	FETTTRANSPORTRING	
	130	947814 00000	PASSFEDER	
	131	003100 52300	DICHTUNG	
	132	008102 52200	SCHLAUCHTUELLE	
	201	040100 52300	FILTERKASTEN (VTLF+DVTLF)	
	201	040102 52300	FILTERKASTEN (DTLF)	
	203	909597 00000	FILTERPATRONE (1x) ²⁾	
	203	909510 20000	FILTERPATRONE (1x) ^{2),3)}	
	205	007900 22200	DICHTUNG	
	207	945349 00000	INNENSECHSKANTSCHRAUBE M10X25	
	209	040200 52200	FILTERDECKEL	
	211	946968 00000	STIFTSCHRAUBE M8X70	
	213	946920 00000	STIFTSCHRAUBE M8X55	
	215	921501 50000	HANDGRIFF	
	217	007900 22500	DICHTUNG	
	218	008900 52200	DICHTUNG	
	219	007800 52300	GEWINDEFLENSCH	
	221	945335 00000	INNENSECHSKANTSCHRAUBE M8X45	
	225	949001 00000	SCHMIERNIPPEL	
	227	008103 52200	SCHLAUCHTUELLE	
	246	742601 52200	SCHLAUCH	
	247	951925 00000	GUMMIFORMTEIL	
	301	040101 52300	FILTERKASTEN (VTLF)	
	301	040103 52300	FILTERKASTEN (DTLF+DVTLF)	
	304	040201 52200	FILTERDECKEL	
	305	000300 52200	DICHTUNG	
	307	945336 00000	INNENSECHSKANTSCHRAUBE M8X50	
	401	002103 22500	KUPPLUNG	
	404	946962 00000	STIFTSCHRAUBE M16X40	
	406	947109 00000	SECHSKANTMUTTER M16	
	416	902230 00000	KUPPLUNGS-RING	
	501	535001 99619	VAKUUMSICHERHEITSENTIL (VTLF)	
	502	539801 52200	SCHALLDÄMPFER	
	503	945346 00000	INNENSECHSKANTSCHRAUBE M8X140	
	505	534005 99619	ABBLASEVENTIL (VTLF)	
	505	534001 99619	DRUCKSICHERHEITSENTIL (DTLF)	
	506	007801 52200	GEWINDEFLENSCH	
	507	945333 00000	INNENSECHSKANTSCHRAUBE M8X35	
	508	953140 00000	DÜSE	
	509	908000 10000	SIEB	
	510	834900 99534	KAPPE	
	520	909510 10000	STAUBABSCHIEDER ⁵⁾	
	635	535006 99619	RÜCKSCHLAGVENTIL ⁴⁾	
	636	025500 52300	DICHTUNG ^{3),4)}	
	637	948074 00000	DICHTUNG ⁴⁾	
	638	945324 00000	INNENSECHSKANTSCHRAUBE M6X55 ⁴⁾	

¹⁾ Dichtungssatz - 54900052300 - Pos.: 118, 125, 131, 205, 217, 218, 305, 636, 637
²⁾ erforderliche Bestellmenge / Wartung
³⁾ nur für VTLF 2.X00/6
⁴⁾ nur für VTLF 2.X00/X-79
⁵⁾ nur für DTLF 2.500/X-69

INDEX	Pos.	Ident No.	Description	
()TLF 2.400-2.500	□	549000 52300	SET OF SEALS ¹⁾	
	2	053200 52300	MOTORFLANGE	
	3	947507 00000	WASHER	
	4	945369 00000	SOCKET HEAD SCREW M12X45	
	7	918300 52300	COVERING HOOD	
	8	901809 00000	SHAFT END BOLD M6X16	
	10	960700 52200	VENTILATOR HOOD	
	15	544500 22500	COUPLING WITH FAN	
	16	949407 00000	WASHER	
	17	945270 00000	HEX-HEAD SCREW	
	19	947654 00000	CYLINDER PIN	
	20	014900 52300	CONNECTION FLANGE	
	20	014901 52300	CONNECTION FLANGE, > 18 KW	
	21	947509 00000	WASHER	
	22	947109 00000	HEX. NUT M16	
	23	011400 52300	DISTANCE-DISC	
	24	951048 00000	STUD M12X40	
	25	741341 00000	RUBBER BUFFER	
	26	950353 00000	DISHED WASHER	
	27	950356 00000	SPHERICAL SEAT WASHER	
	28	945361 00000	HEX-HEAD SCREW M12X40	
	33	743303 00000	SPECIAL GREASE (GREASE PRESS, 50g)	
	40	951933 00000	RUBBER BUFFER	
	41	002501 52300	ELBOW	
	42	945318 00000	SOCKET HEAD SCREW M6X12	
	43	832800 21000	SPACER BOLT	
	44	947504 00000	WASHER	
	45	947104 02000	HEX. NUT M6	
	46	918301 52300	COVERING HOOD (VTLF)	
	46	918302 52300	COVERING HOOD (DTLF)	
	46	918303 52300	COVERING HOOD (DVTLF)	
	47	920800 52200	AIR GUIDE COVER RING	
	49	945323 00000	SOCKET HEAD SCREW M6X35	
	50	945324 00000	SOCKET HEAD SCREW M6X55	
	55	946962 00000	STUD M16X40	
	56	951605 00000	RING UNIT M16	
	57	951919 00000	RUBBER BUFFER	
	101	000100 52300	PUMP BODY	
	102	000700 52300	LID	
	103	000800 52300	LID	
	104	945230 00000	HEX-HEAD SCREW M8X25	
	105	001000 52300	BEARING COVER	
	106	906614 00000	BEARING NU2211 E GBB30	
	107	945328 00000	SOCKET HEAD SCREW M6X50	
	109	906580 00000	SHAFT-SEALING RING	
	110	001101 52300	BEARING COVER	
	111	001100 22500	BEARING COVER	
	112	945319 00000	SOCKET HEAD SCREW M6X16	
	113	945322 00000	SOCKET HEAD SCREW M6X30	
	116	906636 00000	BEARING 3209 C3 GBB20	
	117	948265 00000	SEEGER CIRCLIP	
	118	913112 50100	SEALING RING	
	119	917162 00000	COMPENSATING DISC	
	120	911450 00000	SPACER 45X55X0,025	
	121	911451 00000	SPACER 45X55X0,05	
	122	911413 60000	SPACER 65X85X0,025	
	123	911413 70000	SPACER 65X85X0,05	
	124	948743 00000	STRAIGHT PIN 5X24	

INDEX	Pos.	Ident No.	Description	
	125	917200 20000	SEAL	
	126	901373 01008	ROTOR VANES (KIT) ²⁾	
	127	020000 52300	ROTOR	
	128	068901 22500	GREASE DISTRIBUTION WASHER	
	130	947814 00000	KEY	
	131	003100 52300	GASKET	
	132	008102 52200	CONDUIT-GREASE	
	201	040100 52300	FILTER HOUSING (VTLF+DVTLF)	
	201	040102 52300	FILTER HOUSING (DTLF)	
	203	909597 00000	FILTER CARTRIDGE (1x) ²⁾	
	203	909510 20000	FILTER CARTRIDGE (1x) ²⁾³⁾	
	205	007900 22200	GASKET	
	207	945349 00000	SOCKET HEAD SCREW M10X25	
	209	040200 52200	FILTER COVER	
	211	946968 00000	STUD M8X70	
	213	946920 00000	STUD M8X55	
	215	921501 50000	HANDLE	
	217	007900 22500	GASKET	
	218	008900 52200	GASKET	
	219	007800 52300	CONNECTING FLANGE	
	221	945335 00000	SOCKET HEAD SCREW M8X45	
	225	949001 00000	GREASE NIPPLE	
	227	008103 52200	CONDUIT-GREASE	
	246	742601 52200	FLEXIBLE HOSE	
	247	951925 00000	RUBBER ELEMENT	
	301	040101 52300	FILTER HOUSING (VTLF)	
	301	040103 52300	FILTER HOUSING (DTLF+DVTLF)	
	304	040201 52200	FILTER COVER	
	305	000300 52200	GASKET	
	307	945336 00000	SOCKET HEAD SCREW M8X50	
	401	002103 22500	COUPLING	
	404	946962 00000	STUD M16X40	
	406	947109 00000	HEX. NUT M16	
	416	902230 00000	COUPLING RING	
	501	535001 99619	VACUUM RELIEF VALVE (VTLF)	
	502	539801 52200	SILENCER	
	503	945346 00000	SOCKET HEAD SCREW M8X140	
	505	534005 99619	BLOW-OFF VALVE (VTLF)	
	505	534001 99619	PRESSURE RELIEF VALVE (DTLF)	
	506	007801 52200	CONNECTING FLANGE	
	507	945333 00000	SOCKET HEAD SCREW M8X35	
	508	953140 00000	NOZZLE	
	509	908000 10000	SIEVE	
	510	834900 99534	CAP	
	520	909510 10000	DUST SEPARATOT ⁵⁾	
	635	535006 99619	NON RETURN VALVE ⁴⁾	
	636	025500 52300	GASKET ³⁾⁴⁾	
	637	948074 00000	GASKET ⁴⁾	
	638	945324 00000	SOCKET HEAD SCREW M6X55 ⁴⁾	

¹⁾ Set of seals - 54900052300 - Pos.: 118, 125, 131, 205, 217, 218, 305, 636, 637
²⁾ necessary order quantity / maintenance
³⁾ only for VTLF 2.X00/6
⁴⁾ only for VTLF 2.X00/X-79
⁵⁾ only for DTLF 2.500/X-69

INDICE	Pos.	No. Identification	Designation	FR	
()TLF 2.400-2.500	1	549000 52300	JEU DE JOINTS ¹⁾		
	2	053200 52300	BRIDE DE RACCORDEMENT		
	3	947507 00000	RONDELLE		
	4	945369 00000	VIS HEXAGONALE INTERNE M12X45		
	7	918300 52300	CARTER		
	8	901809 00000	VIS BOUT D'ARBRE M6X16		
	10	960700 52200	CARTER DE VENTILATEUR		
	15	544500 22500	ACCOUPLLEMENT AVEC VENTILATEUR		
	16	949407 00000	RONDELLE		
	17	945270 00000	VIS HEXAGONALE		
	19	947654 00000	CHEVILLE CYLINDRIQUE		
	20	014900 52300	BRIDE POUR MOTEUR		
	20	014901 52300	BRIDE POUR MOTEUR, > 18 KW		
	21	947509 00000	RONDELLE		
22	947109 00000	ECROU A 6 PANS M16			
23	011400 52300	DISQUE DE DISTANCE			
24	951048 00000	PRISONNIER M12X40			
25	741341 00000	AMORTISSEUR EN CAOUTCHOUC			
26	950353 00000	RONDELLE À PORTÉE CONIQUE			
27	950356 00000	RONDELLE À PORTÉE SPHÉRIQUE			
28	945361 00000	VIS HEXAGONALE M12X40			
33	743303 00000	GRAISSE SPÉCIFIQUE (POMPE À GRAISSE, 50g)			
40	951933 00000	AMORTISSEUR EN CAOUTCHOUC			
41	002501 52300	COUDE			
42	945318 00000	VIS HEXAGONALE INTERNE M6X12			
43	832800 21000	BOULON À DISTANCE			
44	947504 00000	RONDELLE			
45	947104 02000	ECROU A 6 PANS M6			
46	918301 52300	CARTER (VTLF)			
46	918302 52300	CARTER (DTLF)			
46	918303 52300	CARTER (DVTLF)			
47	920800 52200	CAPOT DE CANALISATION DE L'AIR			
49	945323 00000	VIS HEXAGONALE INTERNE M6X35			
50	945324 00000	VIS HEXAGONALE INTERNE M6X55			
55	946962 00000	PRISONNIER M16X40			
56	951605 00000	ÉCROU À ANNEAU M16			
57	951919 00000	AMORTISSEUR EN CAOUTCHOUC			
101	000100 52300	CORP DE POMPE			
102	000700 52300	COUVERCLE A DROITE			
103	000800 52300	COUVERCLE A GAUCHE			
104	945230 00000	VIS HEXAGONALE M8X25			
105	001000 52300	COUVERCLE DE ROULEMENTE			
106	906614 00000	ROULEMENT NU2211 E GBB30			
107	945328 00000	VIS HEXAGONALE INTERNE M6X50			
109	906580 00000	BAGUE D'ETANCHEITE			
110	001101 52300	COUVERCLE DE ROULEMENTE			
111	001100 22500	COUVERCLE DE ROULEMENTE			
112	945319 00000	VIS HEXAGONALE INTERNE M6X16			
113	945322 00000	VIS HEXAGONALE INTERNE M6X30			
116	906636 00000	ROULEMENT 3209 C3 GBB20			
117	948265 00000	FREIN D'AXES SEEGER			
118	913112 50100	BAGUE D'ETANCHEITE			
119	917162 00000	DISQUE COMPENSANT			
120	911450 00000	ENTRETOISE 45X55X0,025			
121	911451 00000	ENTRETOISE 45X55X0,05			
122	911413 60000	ENTRETOISE 65X85X0,025			
123	911413 70000	ENTRETOISE 65X85X0,05			
124	948743 00000	GOUPILLE CYLINDRIQUE 5X24			

INDICE	Pos.	No. Identification	Designation	FR	
	125	917200 20000	JOINT		
	126	901373 01008	PALETTE DE CHARBON (KIT) ²⁾		
	127	020000 52300	PISTON		
	128	068901 22500	BAGUE DE TRANSPORT DE GRAISSE		
	130	947814 00000	CLAVETTE		
	131	003100 52300	JOINT		
	132	008102 52200	RACCORD À QUEUE CRANTÉE		
	201	040100 52300	BOITE POUR FILTRE (VTLF+DVTLF)		
	201	040102 52300	BOITE POUR FILTRE (DTLF)		
	203	909597 00000	CARTOUCHE FILTRANTE (1x) ²⁾		
	203	909510 20000	CARTOUCHE FILTRANTE (1x) ²⁾³⁾		
	205	007900 22200	JOINT		
	207	945349 00000	VIS HEXAGONALE INTERNE M10X25		
	209	040200 52200	COUVERCLE DU FILTRE		
	211	946968 00000	PRISONNIER M8X70		
	213	946920 00000	PRISONNIER M8X55		
	215	921501 50000	POIGNEE		
	217	007900 22500	JOINT		
	218	008900 52200	JOINT		
	219	007800 52300	BOURRELET DE RACCORDEMENT		
	221	945335 00000	VIS HEXAGONALE INTERNE M8X45		
	225	949001 00000	GRAISSEUR		
	227	008103 52200	RACCORD À QUEUE CRANTÉE		
	246	742601 52200	TUYAUTERIE FLEXIBLE		
	247	951925 00000	ELEMENT EN CAOUTCHOUC		
	301	040101 52300	BOITE POUR FILTRE (VTLF)		
	301	040103 52300	BOITE POUR FILTRE (DTLF+DVTLF)		
	304	040201 52200	COUVERCLE DU FILTRE		
	305	000300 52200	JOINT		
	307	945336 00000	VIS HEXAGONALE INTERNE M8X50		
	401	002103 22500	ACCOUPLLEMENT		
	404	946962 00000	PRISONNIER M16X40		
	406	947109 00000	ECROU A 6 PANS M16		
	416	902230 00000	DISQUE D'ACCOUPLLEMENT		
	501	535001 99619	SOUPAPE DE SÉCURITÉ - VIDE (VTLF)		
	502	539801 52200	SILENCIEUX		
	503	945346 00000	VIS HEXAGONALE INTERNE M8X140		
	505	534005 99619	SOUPAPE D'ÉCHAPPEMENT (VTLF)		
	505	534001 99619	SOUPAPE DE SÉCURITÉ - PRESSION (DTLF)		
	506	007801 52200	BOURRELET DE RACCORDEMENT		
	507	945333 00000	VIS HEXAGONALE INTERNE M8X35		
	508	953140 00000	AJUTAGE		
	509	908000 10000	TAMIS		
	510	834900 99534	CAPUCHON		
	520	909510 10000	SÉPARATEUR DE LA POUSSIÈRE ⁵⁾		
	635	535006 99619	SOUPAPE DE RETENUE ⁴⁾		
	636	025500 52300	JOINT ³⁾⁴⁾		
	637	948074 00000	JOINT ⁴⁾		
	638	945324 00000	VIS HEXAGONALE INTERNE M6X55 ⁴⁾		

¹⁾ Jeu de joints - 54900052300 - Pos.: 118, 125, 131, 205, 217, 218, 305, 636, 637

²⁾ quantité nécessaire / entretien

³⁾ seulement pour VTLF 2.X00/6

⁴⁾ seulement pour VTLF 2.X00/X-79

⁵⁾ seulement pour DTLF 2.500/X-69

INDICE	Pos.	No. Identificazione	Designazione
()TLF 2.400-2.500	□	549000 52300	SERIE DI GUARNIZIONE ¹⁾
	2	053200 52300	FLANGIA DI RACCORDE
	3	947507 00000	RONDELLA
	4	945369 00000	VITE ESAGONALE INTERNA M12X45
	7	918300 52300	CARTER
	8	901809 00000	VITE DI CHIUSURA ALBERO M6X16
	10	960700 52200	CARTER DEL VENTILATORE
	15	544500 22500	GIUNTO CON VENTILATORE
	16	949407 00000	RONDELLA
	17	945270 00000	VITE ESAGONALE
	19	947654 00000	SPINA CILINDRICA
	20	014900 52300	FLANGIA PER MOTORE
	20	014901 52300	FLANGIA PER MOTORE, > 18 KW
	21	947509 00000	RONDELLA
	22	947109 00000	DADO ESAGONALE M16
	23	011400 52300	DISCO DISTANZA
	24	951048 00000	L'ASTA A VITE M12X40
25	741341 00000	AMMORTIZZATORE IN GOMMA	
26	950353 00000	BASE CONICA	
27	950356 00000	RONDELLA CONICA	
28	945361 00000	VITE ESAGONALE M12X40	
33	743303 00000	GRASSO SPECIALE (INGRASSATORE A PISTOLA, 50g)	
40	951933 00000	AMMORTIZZATORE IN GOMMA	
41	002501 52300	GOMITO	
42	945318 00000	VITE ESAGONALE INTERNA M6X12	
43	832800 21000	DISTANZA BULLONE	
44	947504 00000	RONDELLA	
45	947104 02000	DADO ESAGONALE M6	
46	918301 52300	CARTER (VTLF)	
46	918302 52300	CARTER (DTLF)	
46	918303 52300	CARTER (DVTLF)	
47	920800 52200	CONDOTTA ARIA	
49	945323 00000	VITE ESAGONALE INTERNA M6X35	
50	945324 00000	VITE ESAGONALE INTERNA M6X55	
55	946962 00000	L'ASTA A VITE M16X40	
56	951605 00000	DADO AD OCCHIELLO M16	
57	951919 00000	AMMORTIZZATORE IN GOMMA	
101	000100 52300	CARCASSA	
102	000700 52300	COPERCHIO DESTRA	
103	000800 52300	COPERCHIO SINISTRA	
104	945230 00000	VITE ESAGONALE M8X25	
105	001000 52300	COPERCHIO CUSCINETTO	
106	906614 00000	CUSCINETTO NU2211 E GBB30	
107	945328 00000	VITE ESAGONALE INTERNA M6X50	
109	906580 00000	GUARNIZIONE PER L'ALBERO	
110	001101 52300	COPERCHIO CUSCINETTO	
111	001100 22500	COPERCHIO CUSCINETTO	
112	945319 00000	VITE ESAGONALE INTERNA M6X16	
113	945322 00000	VITE ESAGONALE INTERNA M6X30	
116	906636 00000	CUSCINETTO 3209 C3 GBB20	
117	948265 00000	ANELLO ELASTICO DI SICUREZZA	
118	913112 50100	ANELLO DI TENUTA	
119	917162 00000	SPESSORE	
120	911450 00000	DISTANZIALE 45X55X0,025	
121	911451 00000	DISTANZIALE 45X55X0,05	
122	911413 60000	DISTANZIALE 65X85X0,025	
123	911413 70000	DISTANZIALE 65X85X0,05	
124	948743 00000	PERNO 5X24	

INDICE	Pos.	No. Identificazione	Designazione
	125	917200 20000	GUARNIZIONE
	126	901373 01008	PALETTE (KIT) ²⁾
	127	020000 52300	ROTORE
	128	068901 22500	ANELLO INGRASSAGGIO
	130	947814 00000	CHIAVETTA
	131	003100 52300	GUARNIZIONE
	132	008102 52200	TUBO CONNETTORE
	201	040100 52300	CARCASSA DEL FILTRO (VTLF+DVTLF)
	201	040102 52300	CARCASSA DEL FILTRO (DTLF)
	203	909597 00000	CARTUCCIA FILTRO (1x) ²⁾
	203	909510 20000	CARTUCCIA FILTRO (1x) ²⁾³⁾
	205	007900 22200	GUARNIZIONE
	207	945349 00000	VITE ESAGONALE INTERNA M10X25
	209	040200 52200	COPERCHIO FILTRO
	211	946968 00000	L'ASTA A VITE M8X70
	213	946920 00000	L'ASTA A VITE M8X55
	215	921501 50000	MANETTA
	217	007900 22500	GUARNIZIONE
	218	008900 52200	GUARNIZIONE
	219	007800 52300	FLANGIA DI RACCORDO
	221	945335 00000	VITE ESAGONALE INTERNA M8X45
	225	949001 00000	RACCORDO DI LUBRIFICAZIONE
	227	008103 52200	TUBO CONNETTORE
	246	742601 52200	TUBAZIONE FLESSIBILE
	247	951925 00000	ELEMENTO IN GOMMA
	301	040101 52300	CARCASSA DEL FILTRO (VTLF)
	301	040103 52300	CARCASSA DEL FILTRO (DTLF+DVTLF)
	304	040201 52200	COPERCHIO FILTRO
	305	000300 52200	GUARNIZIONE
	307	945336 00000	VITE ESAGONALE INTERNA M8X50
	401	002103 22500	GIUNTO
	404	946962 00000	L'ASTA A VITE M16X40
	406	947109 00000	DADO ESAGONALE M16
	416	902230 00000	DISCO GUINTO
	501	535001 99619	VALVOLA DI SICUREZZA - VUOTO (VTLF)
	502	539801 52200	SILENZIATORE
	503	945346 00000	VITE ESAGONALE INTERNA M8X140
	505	534005 99619	VALVOLA DI SFIATO (VTLF)
	505	534001 99619	VALVOLA DI SICUREZZA - PRESSIONE (DTLF)
	506	007801 52200	FLANGIA DI RACCORDO
	507	945333 00000	VITE ESAGONALE INTERNA M8X35
	508	953140 00000	UGELLO
	509	908000 10000	CRIVELLO
	510	834900 99534	GUAINA
	520	909510 10000	SEPARATORE DELLE POLVERI ⁵⁾
	635	535006 99619	VALVOLA DI RITENUTA ⁴⁾
	636	025500 52300	GUARNIZIONE ³⁾⁴⁾
	637	948074 00000	GUARNIZIONE ⁴⁾
	638	945324 00000	VITE ESAGONALE INTERNA M6X55 ⁴⁾

¹⁾ Serie di guarnizione - 54900052300 - Pos.: 118, 125, 131, 205, 217, 218, 305, 636, 637
²⁾ quantità di ordinazione necessari / manutenzione
³⁾ solo per VTLF 2.X00/6
⁴⁾ solo per VTLF 2.X00/X-79
⁵⁾ solo per DTLF 2.500/X-69

INDICE	Pos.	No. De pedido	Descripción	
() TLF 2.400-2.500	1	549000 52300	JUEGO DE JUNTAS ¹⁾	
	2	053200 52300	FAROL	
	3	947507 00000	ARANDELA	
	4	945369 00000	TORNILLO HEXAGONAL INTERIOR M12X45	
	7	918300 52300	CAPERUZA DE RECUBRIMIENTO	
	8	901809 00000	TORNILLO TERMINAL DE ÁRBOL M6X16	
	10	960700 52200	CAPERUZA DE VENTILADOR	
	15	544500 22500	MITAD DE ACOPLAMIENTO CON VENTILADOR	
	16	949407 00000	ARANDELA	
	17	945270 00000	TORNILLO DE CABEZA HEXAGONAL	
	19	947654 00000	PASADOR CILÍNDRICO	
	20	014900 52300	BRIDA DE MOTOR	
	20	014901 52300	BRIDA DE MOTOR, > 18 KW	
	21	947509 00000	ARANDELA	
	22	947109 00000	TUERCA HEXAGONAL M16	
	23	011400 52300	PIEZA DISTANCIADORA	
	24	951048 00000	ESPÁRRAGO M12X40	
	25	741341 00000	AMORTIGUADOR DE GOMA	
	26	950353 00000	ANILLO CÓNICO FUERTE	
	27	950356 00000	ARANDELA ESFÉRICA	
	28	945361 00000	TORNILLO DE CABEZA HEXAGONAL M12X40	
	33	743303 00000	GRASA ESPECIAL (PISTOLA DE GRASA, 50g)	
	40	951933 00000	AMORTIGUADOR DE GOMA	
	41	002501 52300	CODO	
	42	945318 00000	TORNILLO HEXAGONAL INTERIOR M6X12	
	43	832800 21000	PERNO DE DISTANCIA	
	44	947504 00000	ARANDELA	
	45	947104 02000	TUERCA HEXAGONAL M6	
	46	918301 52300	CAPERUZA DE RECUBRIMIENTO (VTLF)	
	46	918302 52300	CAPERUZA DE RECUBRIMIENTO (DTLF)	
	46	918303 52300	CAPERUZA DE RECUBRIMIENTO (DVTLF)	
	47	920800 52200	ANILLO CONDUCTOR DE AIRE	
	49	945323 00000	TORNILLO HEXAGONAL INTERIOR M6X35	
	50	945324 00000	TORNILLO HEXAGONAL INTERIOR M6X55	
	55	946962 00000	ESPÁRRAGO M16X40	
	56	951605 00000	TUERCA M16	
	57	951919 00000	AMORTIGUADOR DE GOMA	
	101	000100 52300	CARCASA	
	102	000700 52300	TAPA LATERAL DERECHA	
	103	000800 52300	TAPA LATERAL IZQUIERDA	
	104	945230 00000	TORNILLO DE CABEZA HEXAGONAL M8X25	
	105	001000 52300	TAPA DE COJINETE	
	106	906614 00000	COJINETE NU2211 E GBB30	
	107	945328 00000	TORNILLO HEXAGONAL INTERIOR M6X50	
	109	906580 00000	ANILLO DE JUNTA DE ÁRBOL	
	110	001101 52300	TAPA DE COJINETE	
	111	001100 22500	TAPA DE COJINETE	
	112	945319 00000	TORNILLO HEXAGONAL INTERIOR M6X16	
	113	945322 00000	TORNILLO HEXAGONAL INTERIOR M6X30	
	116	906636 00000	COJINETE 3209 C3 GBB20	
	117	948265 00000	ANILLO DE RETENCIÓN ELÁSTICO	
	118	913112 50100	ANILLO DE JUNTA	
	119	917162 00000	CALCE	
	120	911450 00000	ARANDELA DISTANCIADORA 45X55X0,025	
	121	911451 00000	ARANDELA DISTANCIADORA 45X55X0,05	
	122	911413 60000	ARANDELA DISTANCIADORA 65X85X0,025	
	123	911413 70000	ARANDELA DISTANCIADORA 65X85X0,05	
	124	948743 00000	PASADOR ENTALLADO DE AJUSTE 5X24	

INDICE	Pos.	No. De pedido	Descripción	
	125	917200 20000	JUNTA	
	126	901373 01008	DESPLAZADOR DE CARBÓN (KIT) ²⁾	
	127	020000 52300	ÉMBOLO	
	128	068901 22500	ANILLO DE TRANSPORTE DE GRASA	
	130	947814 00000	CHAVETA	
	131	003100 52300	JUNTA	
	132	008102 52200	EMPALME DE EXTREMIDAD	
	201	040100 52300	CARCASA DE FILTRO (VTLF+DVTLF)	
	201	040102 52300	CARCASA DE FILTRO (DTLF)	
	203	909597 00000	CARTUCHO DE FILTRO (1x) ²⁾	
	203	909510 20000	CARTUCHO DE FILTRO (1x) ²⁾³⁾	
	205	007900 22200	JUNTA	
	207	945349 00000	TORNILLO HEXAGONAL INTERIOR M10X25	
	209	040200 52200	TAPA DE FILTRO	
	211	946968 00000	ESPÁRRAGO M8X70	
	213	946920 00000	ESPÁRRAGO M8X55	
	215	921501 50000	EMPUÑADURA	
	217	007900 22500	JUNTA	
	218	008900 52200	JUNTA	
	219	007800 52300	BRIDA DE EMPALME	
	221	945335 00000	TORNILLO HEXAGONAL INTERIOR M8X45	
	225	949001 00000	BOQUILLA DE LUBRICACIÓN	
	227	008103 52200	EMPALME DE EXTREMIDAD	
	246	742601 52200	MANGUERA	
	247	951925 00000	PIEZA DE FORMA DE GOMA	
	301	040101 52300	CARCASA DE FILTRO (VTLF)	
	301	040103 52300	CARCASA DE FILTRO (DTLF+DVTLF)	
	304	040201 52200	TAPA DE FILTRO	
	305	000300 52200	JUNTA	
	307	945336 00000	TORNILLO HEXAGONAL INTERIOR M8X50	
	401	002103 22500	ACOPLAMIENTO	
	404	946962 00000	ESPÁRRAGO M16X40	
	406	947109 00000	TUERCA HEXAGONAL M16	
	416	902230 00000	DISCO DE ACOPLAMIENTO	
	501	535001 99619	VÁLVULA DE SEGURIDAD - VACÍO (VTLF)	
	502	539801 52200	SILENCIADOR	
	503	945346 00000	TORNILLO HEXAGONAL INTERIOR M8X140	
	505	534005 99619	VÁLVULA DE ESCAPE (VTLF)	
	505	534001 99619	VÁLVULA DE SEGURIDAD - PRESIÓN (DTLF)	
	506	007801 52200	BRIDA DE EMPALME	
	507	945333 00000	TORNILLO HEXAGONAL INTERIOR M8X35	
	508	953140 00000	TOBERA	
	509	908000 10000	CRIBA	
	510	834900 99534	TAPA	
	520	909510 10000	SEPARADOR DE POLVO ⁵⁾	
	635	535006 99619	VÁLVULA DE RETENCIÓN ⁴⁾	
	636	025500 52300	JUNTA ³⁾⁴⁾	
	637	948074 00000	JUNTA ⁴⁾	
	638	945324 00000	TORNILLO HEXAGONAL INTERIOR M6X55 ⁴⁾	

¹⁾ Junta completa - 54900052300 - Pos.: 118, 125, 131, 205, 217, 218, 305, 636, 637

²⁾ cantidad necesario / mantenimiento

³⁾ sólo para VTLF 2.X00/6

⁴⁾ sólo para VTLF 2.X00/X-79

⁵⁾ sólo para DTLF 2.500/X-69