



Wet Score System

Installation Manual
Operating Instruction Manual
Replacement Parts Manual

Wet Score System

Top of the line scoring



- Water line breaks down paper fibers to produce a crack-free perfect fold
- On the right jobs the Wet Score will outperform any mechanical score
- Sets up faster than mechanical score
- Each head equipped with micro-adjust mechanism to ease set up
- Three models to choose from: Manual, Auto Shut Off (shown) and Infinity (for miniature folding - can get heads as close as 1/8" apart and precise water control)
- Makes packaging more economical because folded product lays flatter, less cartons are used.



Table of Contents

Introduction	i
Overview of System	1
Installation of Wet Score System	2
Operation of Wet Score System	9
Initial Start-up of Manual Wet Score (WS)	10
Initial Start-up of Electric Wet Score (EAU)	11
Operating Instructions for Wet Score System	12
Troubleshooting Operation of Wet Score System	15
Safety Data Sheet for SWF 938	17
Parts Manual	21

Congratulations!

You have just purchased the most efficient water score system ever produced. Used in the right application, this unit will outperform any other score system on the market.

This manual includes installation instructions, operational instructions, and a complete parts manual for models WS and EAU. Please save this manual for future reference.

Again, thank you for your purchase and enjoy the benefits and increased profits that the Wet Score system will bring to you.

Overview of the Hydrascore System

The Wet Score system is a simple, efficiently designed system to apply a score line to your folding job. The water/alcohol solution will soak into the paper and break down the paper fibers, allowing a precise fold to occur at the weakened fibers. After a few minutes, the water evaporates and you are left with a precisely folded product with no cracking.

The most common use of the Wet Score is for folding 8-page signatures or an 11" x 17" sheet of paper down to a #10 envelope. It is also used on cover weights as in a 4-page cover and covers printed on C1S (run Wet Score on uncoated side). It is also very effective in doing the backbone fold of 16-page signatures.

As you become more familiar with your Wet Score System, you will find many jobs you can produce a better looking piece with shorter make ready and faster run times.

Enjoy your Wet Score System and if you should have any questions or comments, please do not hesitate to call.

Installation of the Mounting Bar

- A. Locate a hole that is already drilled and taped in the side frame. If you can't find a drilled and taped hole, look for a plain hole through the side frame. Locate this side hole on the other side frame (same location on side frame). See Figure 1.



Figure 1

- B. Using the supplied hardware, bolt the mounting clamp to the side frame. See Figure 2. Remember you only need one bolt to hold the clamp to the frame. The other holes in the clamp are to allow the clamp to fit different models of machines. Repeat clamp mounting on the other side of the machine. Remember to mount clamps so that mounting bar with Wet Score heads is clear of all guards and other machine parts.

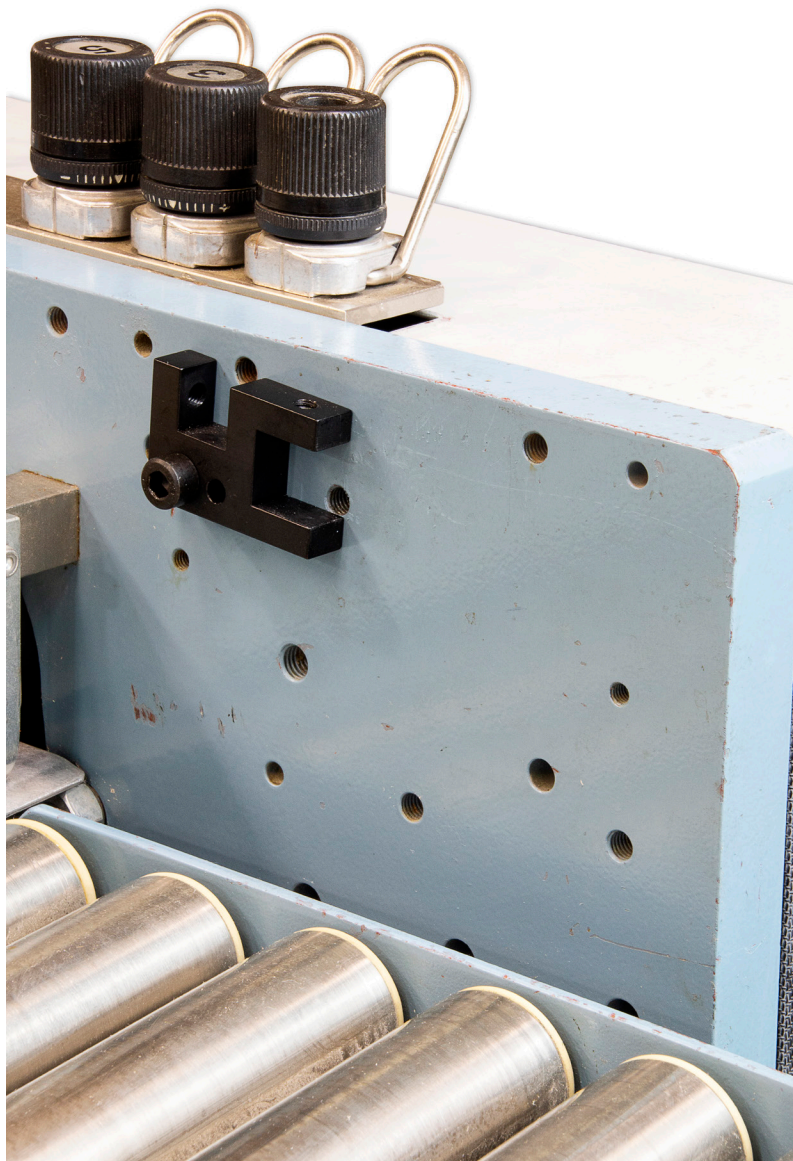

Figure 2

- C. The mounting bar is furnished oversized and must be cut to length. Measure the distance between the frames of your folder. Cut the mounting bar approximately 1/16" shorter than your frame measurement.
- D. Place the mounting bar into the slot provided in the mounting clamp and tighten the set screw.
- E. Mount tank to mounting bar as shown in Figure 3. Secure in place by tightening 10mm hex bolt.

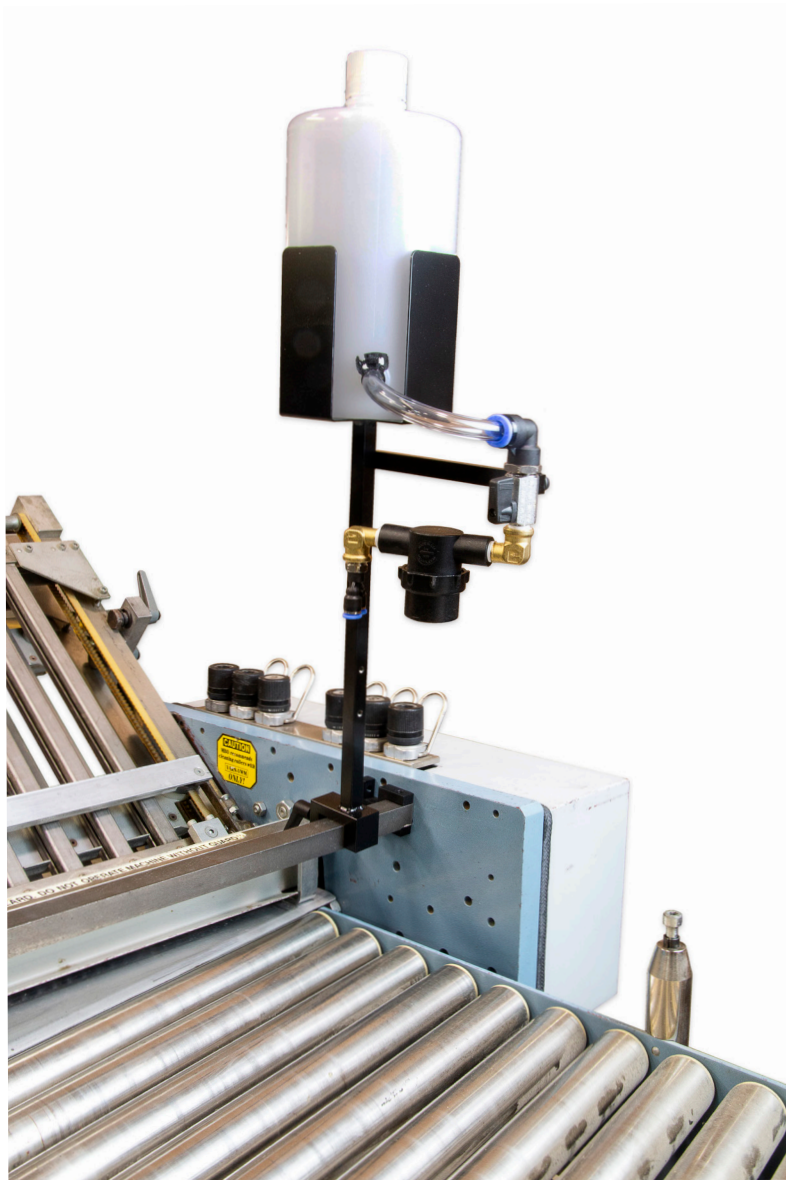

Figure 3

- F. If you've purchased an electric model (EAU), mount tank and photo eye as shown in Figure 4.



Figure 4

- G. Mount Wet Score heads onto the mounting bar as shown in Figure 5. Insert hoses into the filter assembly by pushing the hose into the colored rings firmly until you feel it stop, then pull back to seal the connection.

NOTE: If you have a unit equipped with more than two Wet Score heads, you must first install the 4 way adaptor into the 2 way Y fitting and then install the black supply lines into the 4 way adaptor. If you are using only three heads, there is a plug provided for the fourth hole.

- H. Figure 5 shows a complete installation of a manual Wet Score (WS).



Figure 5

I. Figure 6 shows a complete installation of an electric Wet Score (EAU).



Figure 6

J. Figure 7 shows a close up of the Wet Score heads as they would be used on a job.



Figure 7

Operation of Your Wet Score System

A. Mixing the Wet Score Solution

I. When scoring the offset, bond, or coverstock, we have found the best solution to be a mixture of Isopropyl Alcohol and water. A mixture of approximately 35% alcohol and 65% water is recommended. If your stock has very heavy ink coverage at the point of scoring, a heavier concentration of alcohol is recommended. **DO NOT** exceed 50% alcohol concentration.

If you would prefer to use an alcohol substitute, we recommend Super Wet Fold 938 (SWF 938). A sample of this product is included with your Wet Score.

Mixing Instructions for SWF 938:

Using a 1-gallon container, add 4 oz. of SWF 938. Fill balance of container with water. Mix well. Depending on type of paper and ink coverage, you may want to alter this mixture to your preference.

Initial Start-up of Manual Wet Score (WS)

1. Fill the tank with wetting solution.
2. Re-install tank cap. Remember to leave the cap loose so the solution tank can breathe.
NOTE: When not using the Wet Score system, it is recommended to tighten the cap on the tank. This will prevent evaporation of the wetting solution and dust getting into the tank. Remember to loosen the cap when you next use the system to prevent airlock.
3. Open the main valve on the water tank assembly.
4. Open the needle valve adjustments on each individual head.
5. In a few seconds, as the filter and hoses fill, your wetting solution will begin to drip from the heads.* The unit is now ready to use. Close the main valve on the tank and proceed to Operating Instructions (pages12-14).
*As solution begins to drip from each individual head, you can close the adjusting valve.

Initial Start-up of Electric Wet Score (EAU)

1. Fill the tank with wetting solution.
2. Re-install tank cap. Remember to leave the cap loose so the solution tank can breathe.
3. Slide paper under the photo eye. The red light on the photo eye will illuminate, indicating that the photo eye is active.
4. Open the needle valve adjustments on each individual head.
5. In a few seconds, as the filter and hoses fill your wetting solution will begin to drip from each individual head. As the solution begins to drip from each head, you can close the adjusting valve. The unit is now ready to use. Remove your paper from underneath the photo eye and proceed to Operating Instructions (pages 12-14).

Operating Instructions for the Wet Score System

1. Set up folder as you normally would, except your Wet Score system will replace your mechanical score blades.
2. Select the appropriate size needle (see chart below).

Needle Size	Paper Weight
22GA	35-45# offset 16-18# bond 60-70 GSM
20GA	50-70# offset 20-28# bond 70-100 GSM 30-40# cover
18GA	70-90# offset 105-250 GSM 45-110# cover CS1 cover

3. Install selected needle onto the Wet Score head by simultaneously pushing the needle into the end of the needle adaptor and turning the needle. The needle will turn approximately 1/4 turn and lock in place. The needle is now secure. To remove the needle, reverse the above process.

4. Position Wet Score head so the needle just lightly contacts the sheet at the point where you want the score to occur. The head should be positioned at approximately a 45° angle to the sheet travel (see figure below).



Figure 8

5. Adjust the water flow so the needle produces a wet line in the paper that is about the width of a pencil line. The line must run the full length of the sheet.
6. If the line is too wide, you will not produce accurate folding because you will confuse the folder regarding where you want the fold to occur.
7. If the line is too narrow, especially on heavy sheets of paper, the water will not soak all the way through and the backbone will crack.

Troubleshooting Operation of the Wet Score System

A. Water line is too wide:

1. Adjust the needle valve to slow the amount of water flowing to the needle.
2. Use a smaller gauge needle.

B. Water line is too narrow:

1. Adjust the needle valve to increase the amount of water flowing to the needle.
2. Use a larger gauge needle.

C. Water line is non-existent:

1. The filter may be clogged. Clean the filter.
2. The cap may be on too tight, causing air lock. Loosen the cap.
3. The needle valve may be defective. Replace the needle valve.
4. The needle may be clogged. Replace or clean the needle.
5. (Manual model only) The sensor may be defective. Replace the sensor.
6. (Electric Model only) The solenoid valve may be defective. Replace the solenoid valve or coil.

D. Water line skips:

1. Needle may be too far from the paper. Adjust the needle so it is closer to the paper.
2. There may not be enough flow to the needle. Adjust the needle valve to allow more water flow.
3. The needle may be too small. Use a larger needle.

E. Solution leaks from hose connections:

1. Remove hose and re-install. Pull hose tight to seat line.
2. If your Wet Score System is more than one year old, leaks may be caused by impressions from the hose fittings. Remove the hose, cut the hose behind the existing indents and reinsert into fitting.

Backbone Softener

1 PRODUCT AND COMPANY IDENTIFICATION

Product Identifier: Backbone Softener SW938, SW938/30, SW938/5, SW938/55
Synonyms: none
Common Name: Lubricant
SDS Number: Backbone Softener
Product Code: Backbone Softener
Revision Date: 1/22/2015
Version: 1
CAS Number: N/A
EPA Number: N/A
Chemical Family: Silicone lubricants
Product Use: Diluted and applied to paper to soften paper fold
Supplier Details: Graftsolve Company
 1550 24th St.
 North Chicago, Illinois 60064

Emergency: Infotrac 800-535-5053
Contact: George Widmar
Phone: 847-775-4550
Fax: 847-887-0681
Email: george@grafsolve.com
Web: grafsolve.com

2 HAZARDS IDENTIFICATION

Classification of the substance or mixture

GHS Classification in accordance with 29 CFR 1910 (OSHA HCS):

Health, Acute toxicity, 5 Oral
 Health, Serious Eye Damage/Eye Irritation, 2 B

GHS Label elements, including precautionary statements

GHS Signal Word: WARNING

GHS Hazard Pictograms:

no GHS pictograms indicated for this product

GHS Hazard Statements:

H303 - May be harmful if swallowed
 H320 - Causes eye irritation

GHS Precautionary Statements:

P101 - If medical advice is needed, have product container or label at hand.
 P102 - Keep out of reach of children.
 P264 - Wash _ thoroughly after handling.
 P281 - Use personal protective equipment as required.
 P301+310 - IF SWALLOWED: Immediately call a POISON CENTER or doctor/physician.
 P302+352 - IF ON SKIN: Wash with soap and water.
 P305+351+338 - IF IN EYES: Rinse continuously with water for several minutes. Remove contact lenses if present and easy to do. Continue rinsing.
 P363 - Wash contaminated clothing before reuse.
 P376 - Stop leak if safe to do so.

Route of Entry: Eyes; Ingestion; Inhalation; Skin;
Inhalation: Under normal conditions, should not cause irritation.
Skin Contact: Under normal conditions, should not cause irritation.
Eye Contact: May cause irritation.

Ingestion: Ingestion is not an applicable route of entry for intended use, but if accidentally ingested obtain emergency medical attention

3 COMPOSITION/INFORMATION ON INGREDIENTS

Ingredients:

Cas#	%	Chemical Name
-40-7		Proprietary

4 FIRST AID MEASURES

Inhalation: If symptoms develop, move victim to fresh air. If symptoms persist, obtain medical attention. No vapors appear at normal working temperature. Give oxygen or artificial respiration if needed.

Skin Contact: Promptly flush skin with water until all chemical is removed.
Remove contaminated clothing and wash before reuse.

Wash with soap and water.

Eye Contact: Immediately flush eyes with large amounts of water for at least 15 minutes, lifting eyelids occasionally to facilitate irrigation.
Get immediate medical attention if irritation persists.

Ingestion: Get prompt, qualified medical attention.

5 FIRE FIGHTING MEASURES

Flammability: none

Flash Point: Flash Point exceeds 212f

Flash Point Method: Tagliabue Closed Cup

Burning Rate: na

Autoignition Temp: na

LEL: nd

UEL: nd

6 ACCIDENTAL RELEASE MEASURES

Avoid contact with eyes.

Do not discharge into drains.

Keep away from drains and ground water.

Pick up excess with inert absorbant material and place into separate waste container.

Watch out for slippery conditions when spillage.

7 HANDLING AND STORAGE

Handling Precautions: Avoid contact with eyes, skin, or clothing. Consider normal working hygiene. Do not puncture or drop containers.
Handle with care and avoid spillage on the floor (slippage). Keep material out of reach of children.
Launder contaminated clothing. Wash thoroughly after handling.

Storage Requirements: Protect container and its fittings from physical damage.

Engineering Controls: Use local exhaust at filling zones and where leakage is probable.
Personal Protective Equipment: HMIS PP, D | Face Shield and Eye Protection, Gloves, Apron
 HMIS PP, X | Consult your supervisor for special instructions

Exposure Limits:

USA OSHA (TWA₅)/PEL): ND

ACGIH (TWA/TLV): ND

DFG (MAK): ND

Respiratory Protection: None required

Ventilation: none required

Protective Gloves: Yes

Eye Protection: Goggles

Other Protective Equipment: See Supervisor

Appearance: Clear/hazy Liquid
Physical State: Liquid
Odor: Light detergent
Odor Threshold: NA
Molecular Formula: NA
Particle Size: NA
Solubility: Complete in Water
Spec Grav./Density: .986
Softening Point: NA
Viscosity: NA
Percent Volatile: 0
Saturated Vapor Concentration: NA
Boiling Point: Greater than 212f
Freezing/Melting Pt.: Freeze point 32f
Flammability: none
Flash Point: Greater than 200f
Vapor Pressure: Not Established/NA
Vapor Density: Heavier than air
pH: 6-8
VOC: 0
Evap. Rate: Slower than water
Bulk Density: 8.23 lbs per gal

Chemical Stability: Stable
Conditions to Avoid: None known
Materials to Avoid: None known
Hazardous Decomposition: None
Hazardous Polymerization: Will not occur

Not Determined

Not Determined

13

DISPOSAL CONSIDERATIONS

Dispose of in accordance with local regulations.

14

TRANSPORT INFORMATION

Compound Cleaning Liquid Non-Hazardous NMFC # 48580

15

REGULATORY INFORMATION

NA

NA

16

OTHER INFORMATION

NFPA: Health = 1, Fire = 0, Reactivity = 0, Specific Hazard = None

HMIS III: Health = 1(Chronic), Fire = 0, Physical Hazard = 0

HMIS PPE: D - Face Shield and Eye Protection, Gloves, Apron

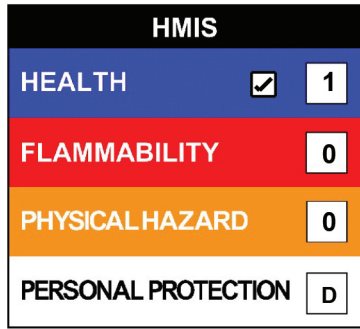

Author:

Publication Date:

Revision No.

Disclaimer:

Although reasonable care has been taken in the preparation of this document, we extend no warranties and make no representations as to the accuracy or completeness of the information contained herein, and assume no responsibility regarding the suitability of this information for the user's intended purposes or for the consequences of its use. Each individual should make a determination as to the suitability of the information for their particular purpose(s).

The above information is not claiming characteristics of the product in term of legal claims of performance / guarantee.

This information is given in good faith and based on our current knowledge of the product.

Hydra Score

Applicator Head Assy

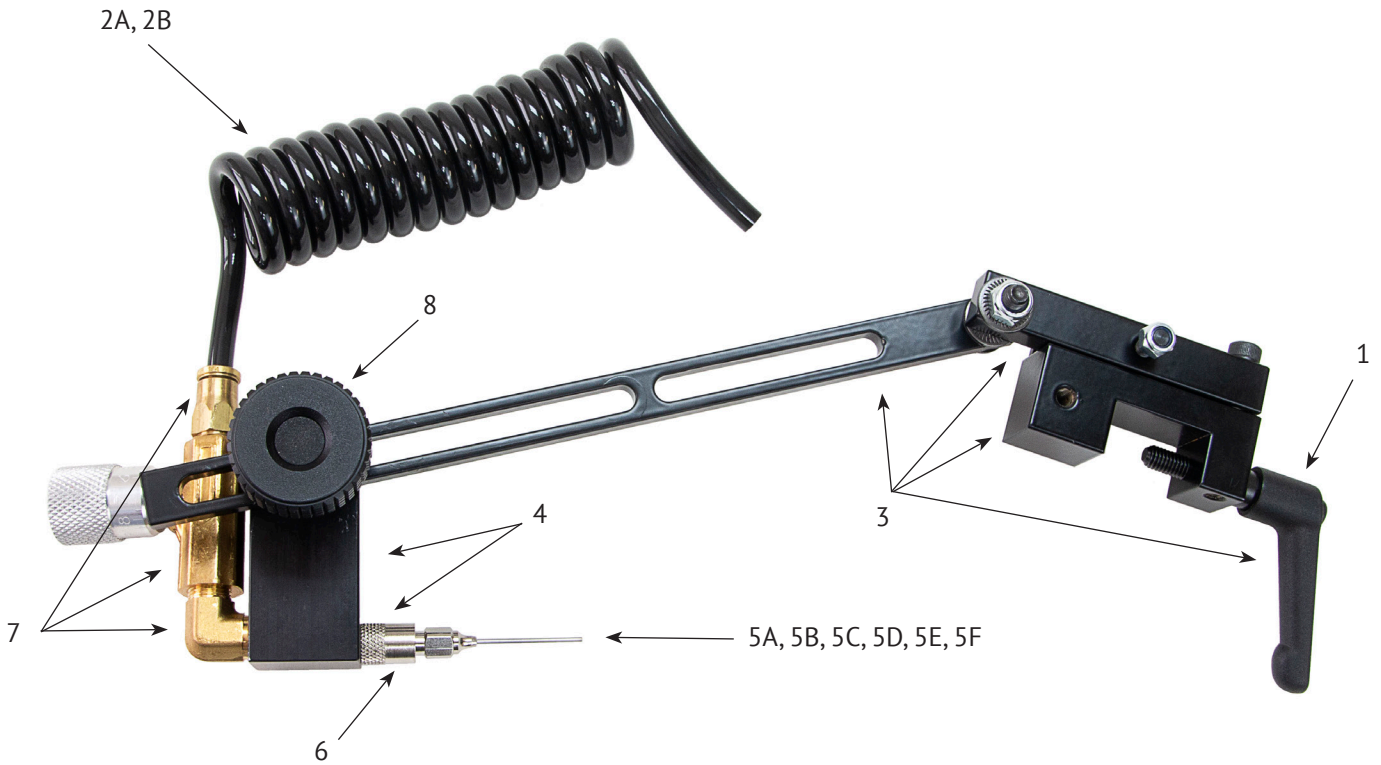

Index	Part Number	Description
1	99HS117	Clamp Handle
2A	99HS107	Hose, 3.5 ft
2B	99HS108	Hose, 10 ft
3	99HS136	Hydrascore Mounting Arm
4	99HS125	Junction Block
5A	99HS126	Needle 18 Gauge x 1"
5B	99HS127	Needle 20 Gauge x 1"
5C	99HS128	Needle 22 Gauge x 1"
5D	99HS129	Needle 18 Gauge x 2"
5E	99HS130	Needle 20 Gauge x 2"
5F	99HS133	Needle 22 Gauge x 2"
6	99HS131	Needle Adapter
7	99HS132	Needle Valve Assembly
8	99HS121	Knob

Hydra Score

Manual Tank Assy

Index	Part Number	Description
1	99HS014	Tank Cap
2	99HS002	Tank Assy (includes cap)
3	99HS020	Hose Clamp (not shown)
4	99HS003	Hose
5	99HS018	Ball Valve Assy
6	99HS019	Filter Assy
7	99HS117	Clamp handle
8	99HS001	Tank Holder Assy
9	99HS011	2 Way Valve Assy
10	99HS010	Plug Only
11	99HS017	4 Way Valve Assy

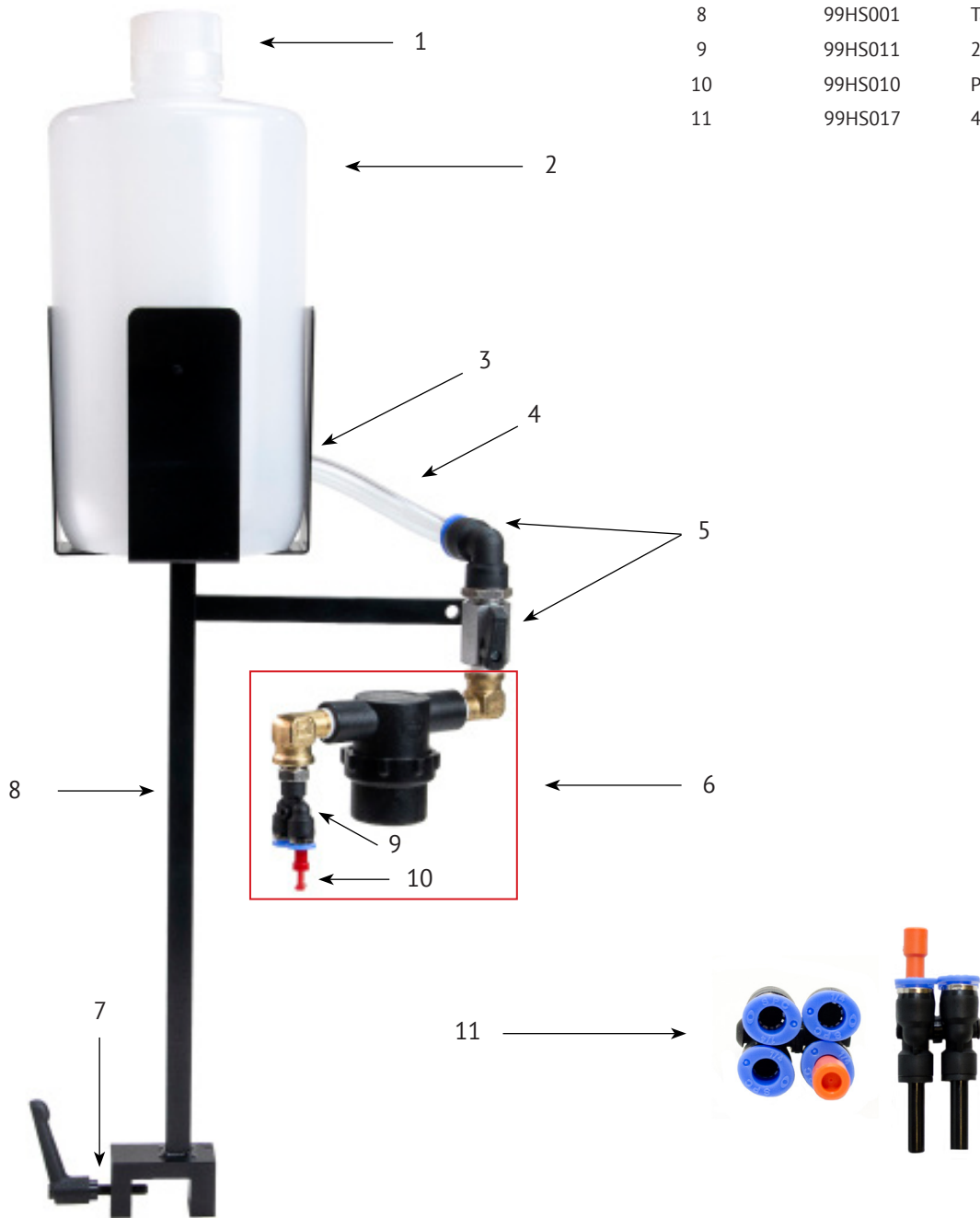

Hydra Score

Auto Electric Tank Assy

Index	Part Number	Description
1	99HS014	Tank Cap
2	99HS002	Tank Assy (includes cap)
3	99HS020	Hose Clamp (not shown)
4	99HS003	Hose
5	99HS006	Right Angle Swivel Fitting
6	99HS135	Solenoid Valve Assy 24 VAC
7	99HS069	Filter Assy
8	99HS058	Encloser Box
9	99HS059	Junction Block (N/S Inside Box)
10	99HS065	Transformer Plug
11	99HS117	Clamp Handle
12	99HS001	Tank Holder Assy
13	99HS066	Strain Relief (2 used)
14	99HS050	Wire Cable
15	99HS011	2 Way Valve
16	99HS010	Plug Only
17	99HS017	4 Way Valve Assy

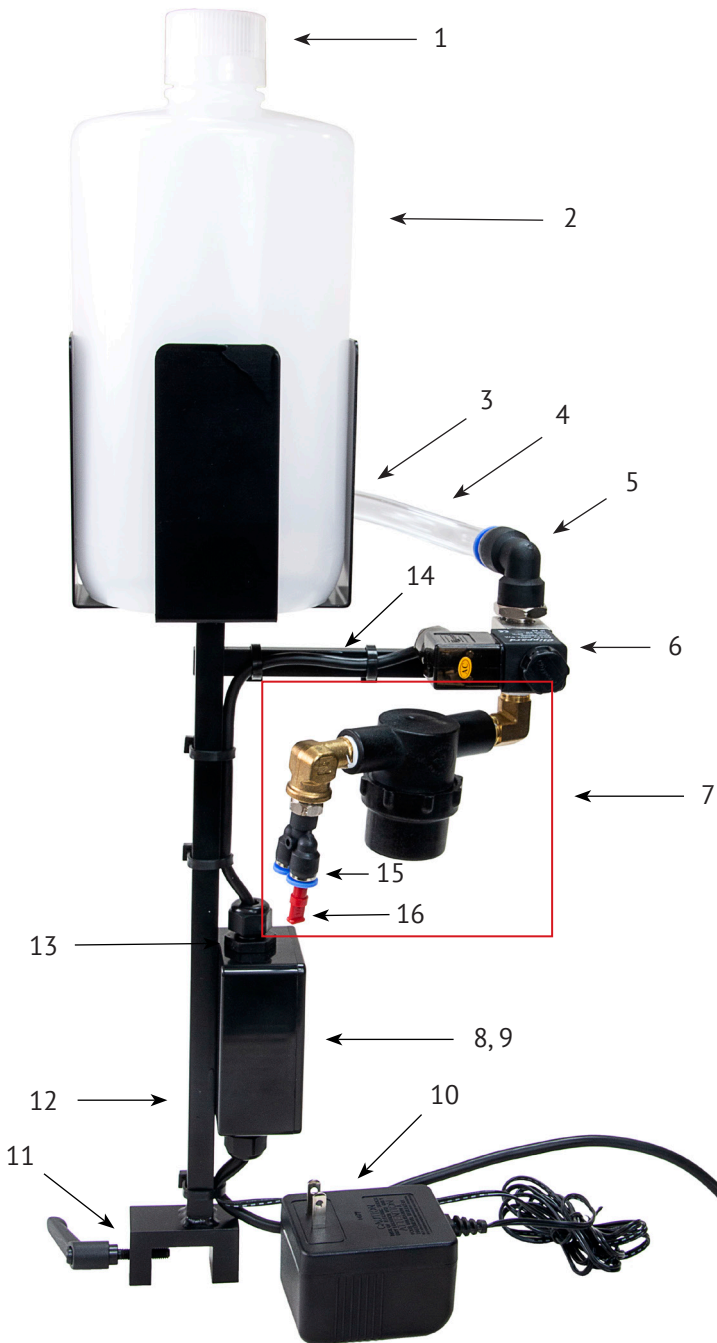

17 →



Hydra Score

Photo Eye Assy

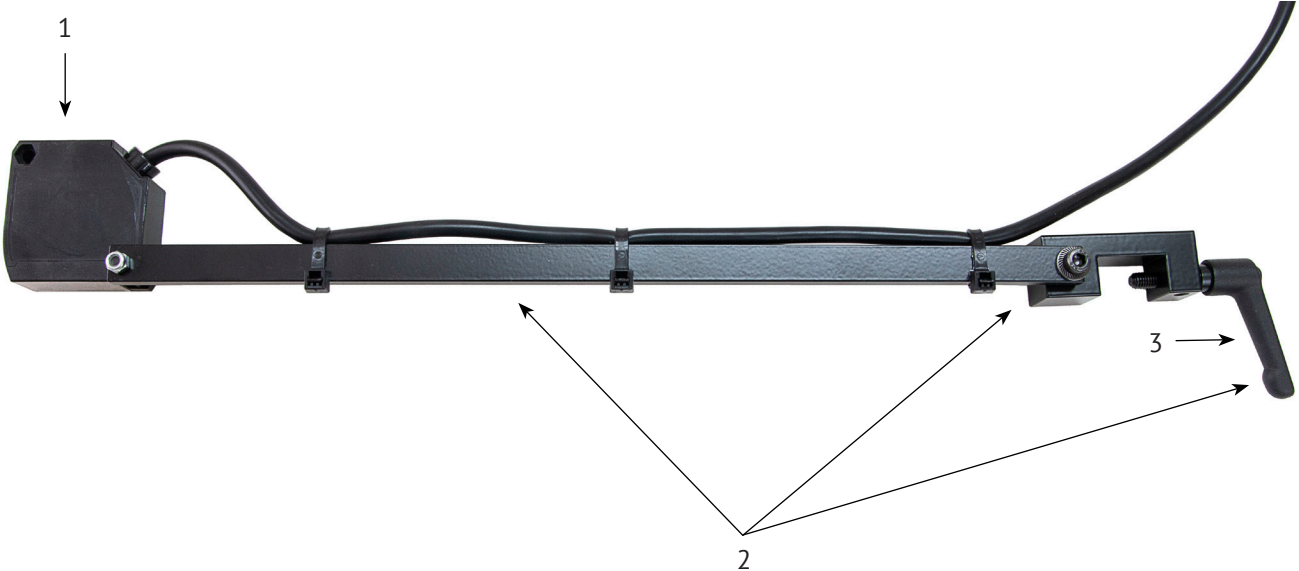

Index	Part Number	Description
1	99HS070	Photo Eye w/ Cable
2	99HS137	Eye Mounting Assy
3	99HS117	Clamp Handle Only





